

Owner's Manual





U.S. vehicles only

"REPORTING SAFETY DEFECTS

If you believe that your vehicle has a defect which could cause a crash or could cause injury or death, you should immediately inform the National Highway Traffic Safety Administration (NHTSA) in addition to notifying **BMW of North America, Inc., P.O. Box 1227, Westwood, New Jersey 07675-1227, Telephone (201) 307-4000.**

If NHTSA receives similar complaints, it may open an investigation, and if it finds that a safety defect exists in a group of vehicles, it may order a recall and remedy campaign. However, NHTSA cannot become involved in individual problems between you, your dealer, or BMW of North America, Inc.

To contact NHTSA, you may either call the **Auto Safety Hotline toll-free at 1-800-424-9393 (or 366-0123 in Washington, DC area) or write to: NHTSA, US Department of Transportation, Washington, DC 20590.** You can also obtain other information about motor vehicle safety from the Hotline."

Warning:

Use unleaded gasoline only. Fuels containing up to and including 10% Ethanol or other oxygenates with up to 2.8% oxygen by weight (i.e. 15% MTBE or 3% Methanol plus an equivalent amount of co-solvent) will not void the applicable warranties respecting defects in materials or workmanship.

Only use fuels advertised to have deposit control additives, which keep intake valves and intake system clean or which "meet BMW standards of intake valve cleanliness" for either "up to 50,000 miles" or "for unlimited mileage". If such fuels are not available in your area, consult your BMW dealer, who can recommend a fuel additive that will provide sufficient detergency to assure proper engine cleanliness, when used in accordance with product instructions.

Field experience has shown that there are significant differences in fuel quality (i.e. volatility, composition, additives, etc.) among gasolines offered for sale in the United States. The use of poor quality fuels may result in driveability, starting and stalling problems especially under certain environmental conditions, such as high ambient temperature and high altitude.

If driveability problems occur and are suspected to result from the fuel being used, it is recommended that you switch to a fuel known to be of good quality.

Failure to comply with these recommendations may result in unscheduled maintenance.

Obey pertinent safety rules when you are handling gasoline.

Important safety information!

For your own safety, use genuine parts and accessories approved by BMW.

When you use accessories tested and approved by BMW and Original BMW Parts, you have the guarantee that their suitability for your vehicle has been thoroughly tested by BMW.

BMW warrants these parts to be free from defects in material and workmanship.

BMW will not accept any liability for any spare parts and accessories not approved by BMW.

BMW cannot test every product from other manufacturers to verify if it can be used on a BMW safely and without risk to either the vehicle, its operation, or its occupants.

Original BMW Parts, BMW Accessories and other products approved by BMW, together with professional advice on using these items, are available from all BMW dealers.

Installation of non-approved aftermarket Accessories such as alarms, radios, amplifiers, radar detectors, telephones, wheels, springs, brake dust shields etc. may cause extensive damage to the vehicle, impact its safety and affect the validity of the BMW Limited Warranty. Please see your BMW dealer for further information.

"Maintenance, replacement, or repair of the emission control devices and systems may be performed by any automotive repair establishment or individual using any certified automotive part".

air of the
ems may
repair es-
certified



850i

BMW AG

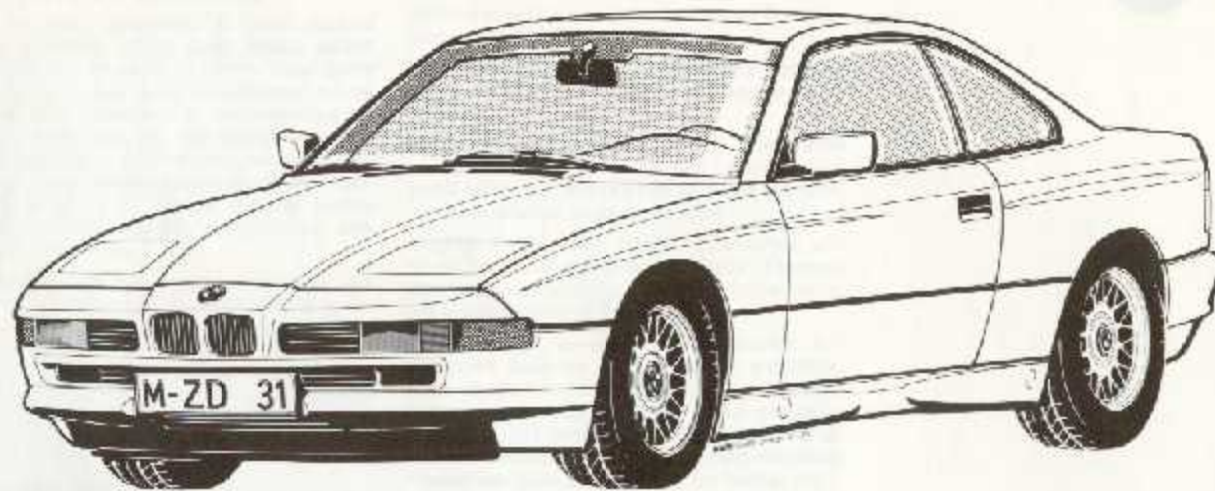

Congratulations on your choice of a BMW

The better acquainted you are with your car, the more pleasurable it will be to drive it. Therefore, we request that you heed the following advice:

In this Owner's Manual you will find important information concerning operating instructions, vehicle care, maintenance and technical details for your new BMW. Please read it carefully before taking your first drive, so that you are fully familiar with the technical advantages of your BMW. A comprehensive index will aid you in finding more detailed information on the various features and operations of your new car.

Please keep in mind that regular care and maintenance are necessary for the operational safety of your vehicle as well as to maintain its resale value.

This Owner's Manual should be considered a permanent part of this vehicle. It should stay with the vehicle when sold to provide the next owner with important operating, safety and maintenance information.

This manual is supplemented by a Service Booklet and a Warranty Booklet. We recommend that you read these publications thoroughly.

Your BMW is covered by the following warranties:

- Limited Warranty
- Limited Warranty - Rust Perforation
- Emissions - System Defect Warranty
- Emissions Performance Warranty
- California Emissions Control System Limited Warranty

Detailed information about these warranties is listed in BMW's Consumer Warranty Booklet.

We wish you many safe and pleasant journeys.

BMW AG

Bayernische Motoren Werke
Aktiengesellschaft

In the interests of continuing technical development, we reserve the right to modify designs, equipment and accessories.

Dimensions, weights and performance data quoted in this manual are to the tolerances established by the German Institute for Industrial Standards (DIN).

Claims based on data, statements, descriptions or illustrations, errors or omissions in this Owner's Manual will not be entertained.

Please note that any discrepancies between your BMW and the details given here may be due to the equipment specifications offered on a particular model or the items ordered with the car.

This manual applies to U. S. and Canadian models only.

Some equipment shown in this manual will pertain only to one model. In Canada this manual is also available in French. To obtain a copy, contact your BMW dealer.

For operating instructions of options not listed in this Owner's Manual, please

refer to the Operating Instructions or Owner's Manual for those options.

Any modification to the car and its equipment may effect its operational reliability, vehicle safety and resale value.



© 1990 Bavarian Motor Works (BMW) AG
Munich, West Germany
Not to be reproduced wholly or in part without written
permission of BMW AG, Munich
Order No. 01479782609
US \$ 5.90
Printed in West Germany

At a glance



Operating instructions



Hints



Vehicle care



Technical data



Index A-Z

Operating Instructions

Read the instructions carefully before using the product. The instructions should be read and understood by all users of the product. The instructions should be read and understood by all users of the product.

The instructions should be read and understood by all users of the product. The instructions should be read and understood by all users of the product.

The instructions should be read and understood by all users of the product. The instructions should be read and understood by all users of the product.

The instructions should be read and understood by all users of the product. The instructions should be read and understood by all users of the product.

The instructions should be read and understood by all users of the product. The instructions should be read and understood by all users of the product.

Cockpit	10
Instrument panel	11
Indicator and warning lights	12
Horn, odometer	13
Tachometer, fuel gauge, coolant temperature gauge	14
Ignition switch, starting the engine	15
Break-in	16
Energy-conscious driving	18
Fuel refilling	19
Tire pressure	20

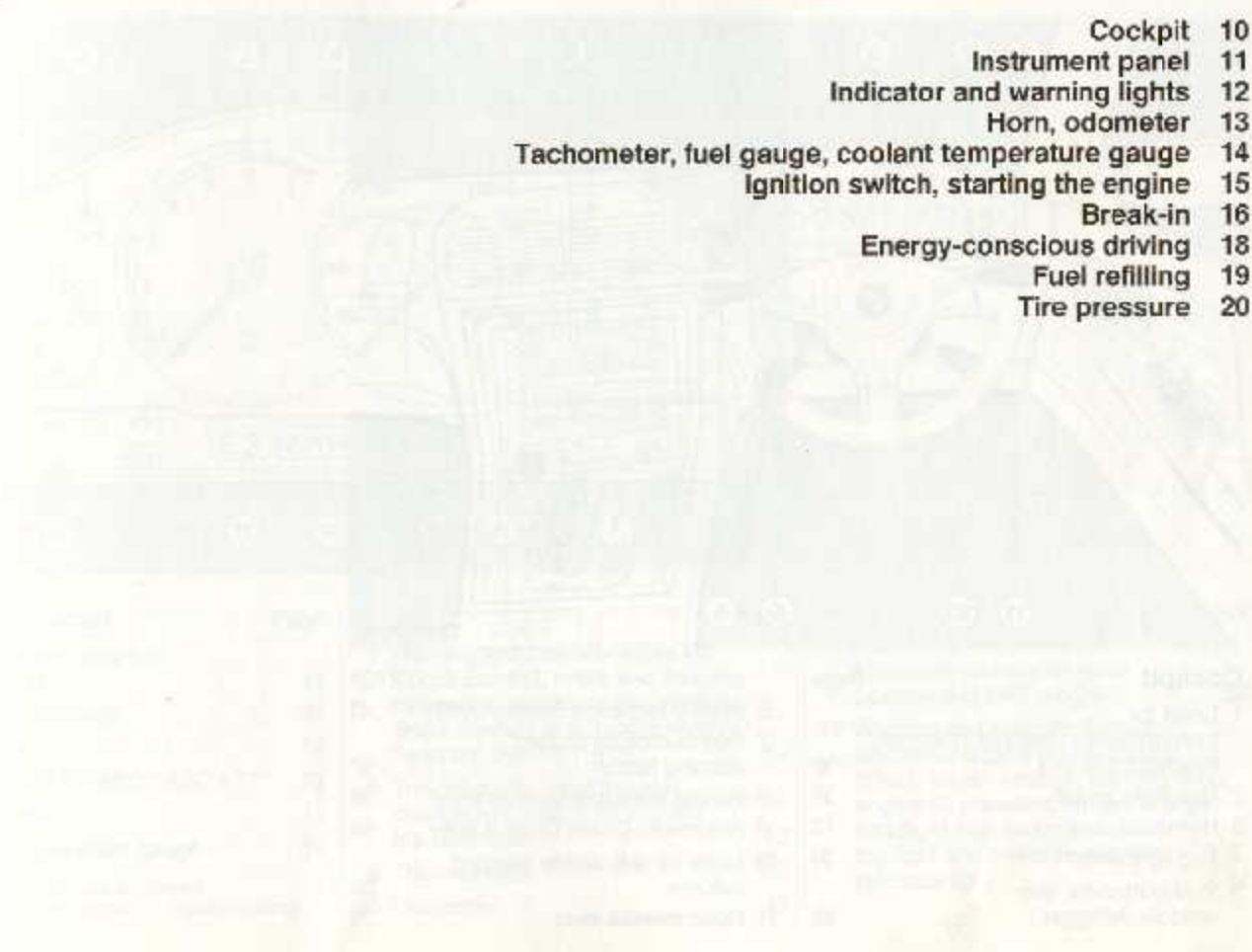

At a glance

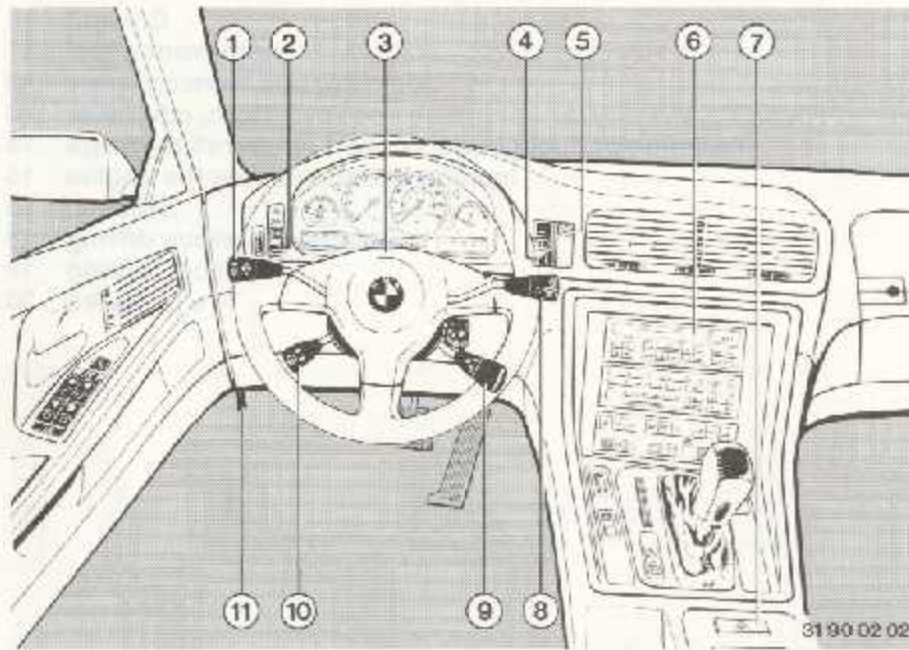

3190 02 02

Cockpit

	Page		Page
1 Lever for turn indicators; headlight dimmer, headlight flashing	36	6 Multi-Information Display (MID)	42
2 Headlight switch	36	7 Pushbutton for hazard warning flasher	37
3 Horns	13	8 Windshield wiper/washer lever	38
4 Fog light switch	36	9 Automatic Cruise Control lever	60
5 Pushbutton for rear window defogger	65	10 Lever for adjustable steering column	30
		11 Hood release lever	75

Instru

1 Fuel warning
2 Turn
3 Tach
4 Indio
5 Spee
6 Cool
* ASC
** ASC

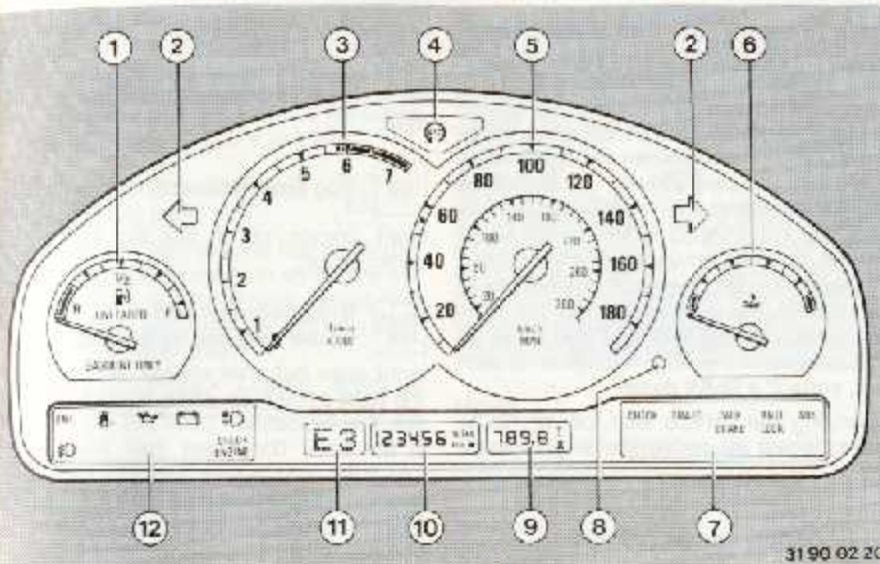

Instrument panel

	Page
1 Fuel gauge with low fuel warning light	14
2 Turn signal indicator	36
3 Tachometer	14
4 Indicator light for ASC+/ASC+T	12
5 Speedometer	13
6 Coolant temperature gauge	14

+ASC Automatic Stability Control
 +ASC+T Automatic Stability + Traction Control

	Page
7 Warning and indicator lights for Check Control, brake and steering hydraulics, parking brake, Antilock Brake System and Supplementary Restraint System (SRS)	12
8 Trip odometer resetting and changeover switch for second trip odometer	13
9 Trip odometer	13
10 Odometer	13

	Page
11 Display for automatic transmission selector-lever position and shift program	57
12 Warning and indicator lights for electronic engine power control (EML), fasten seatbelt warning lamp, engine oil pressure, battery charge, headlight high beam indicator, fog light and emission related indicator light	12

At a glance

Indicator and warning lights



Indicator for ASC¹/ASC + T²

Light goes out after engine has started. System is working.

For further information: See page 61.



Turn signals left/right

Comes on simultaneously when operating the turn signals.



Electronic engine power control

With the ignition key in position 2 the light goes on shortly and signals a working system. A malfunctioning system is indicated if the light stays on or lights up while driving. Consult your BMW dealer and drive at low engine speeds.



Emission-related indicator³

Light goes out after engine has started. If the indicator lights up or flashes, the engine still can be driven but the emission-related electronics should be inspected.

¹ ASC Automatic Stability Control

² ASC + T Automatic Stability + Traction Control

³ US models only



Engine oil pressure warning light

Light goes out after engine has started.

If the warning light comes on briefly at idle speed, this should cause no alarm, provided that it goes off when the accelerator is partially pressed down. If the red oil pressure warning light or the description "ENGINE OIL PRESS LOW" in the MID⁴ comes on while driving, pull off the road to a safe stop and declutch or select neutral immediately and switch off the ignition. Check the oil level and add more oil if necessary. If the engine oil level is correct, consult a BMW dealer.

Operating the vehicle with low or no oil pressure will cause severe engine damage.



Battery charge indicator

Light goes out after engine has started. If the red battery charge indicator comes on during a trip, have the car checked to determine the cause of the problem, otherwise the battery will be discharged completely.

Caution:

If the V-belt is defective, a higher effort for steering and braking is needed.

⁴ MID Multi-Information Display



Headlight high beam indicator

Light comes on when the high beams are on and when the headlight flasher is operated.



Fog light indicator

Light comes on if the fog lights are switched on.



Brake booster and power steering hydraulics



Light goes out after engine has started. If the light comes on while driving and you see the indication "LOW BRAKE FLUID" in the MID: The brake fluid level is too low. If the light flashes and you see the indication "BRAKE ASSIST INACT." in the MID: Pressure has been lost in the brake booster or power steering system.

Warning:

A much higher effort than usual will be needed to produce the anticipated braking and steering effect.

Driving with the brake warning light on and the indication "LOW BRAKE FLUID" in the MID can result in an accident. Have your brake system checked immediately.

For further information: See page 80.

⁵ Pictogram for Canadian models



This park after the on when



Light go the warn is in mo indicate: tem has Although lost, not made.

icator

reams are
er is oper-

ights are

s (C)

started. If
and you
E FLUID"
rel is too
se the in-
" in the
he brake

il will be
ed brak-

light on
E FLUID"
nt.
immedi-

80.

Parking brake indicator (C)

The parking brake indicator light goes out after the engine has started and will come on when the parking brake is applied.

Antilock Brake System warning light (C)

Light goes out after engine has started. If the warning light comes on when the car is in motion at normal driving speed, this indicates that the Antilock Braking System has developed a fault.

Although the antilock braking effect is lost, normal brake applications can still be made.



3190 0124

Horn

The horns are sounded by pressing the horn symbols on the steering wheel.

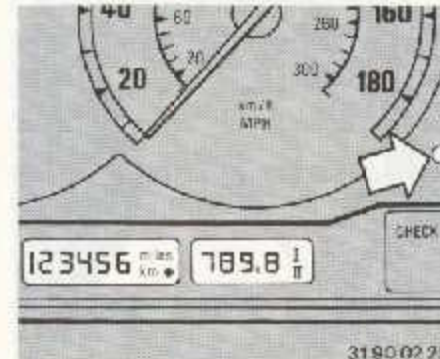

3190 0225

Odometer

The odometer registers the distance in miles (for Canada in kilometers).

Trip odometer I and II

Two independent trip odometers can be started and reset to zero. Both count up to 999.9 miles (kilometers).

Selecting trip odometers I and II:

- Turn the knob (arrow) clockwise.

Reset to zero:

- Push when the appropriate trip odometer is in the display.

Displaying and setting is still possible two minutes after the ignition is switched off.

¹⁾ Photogram for Canadian models

At a glance



Tachometer

Avoid excessive engine speeds in any portion of the red warning zone, particularly when driving downhill or in lower gears.

The fuel injection control unit incorporates a cutout to limit maximum engine speed. This takes effect when the needle of the tachometer reaches the red warning zone.

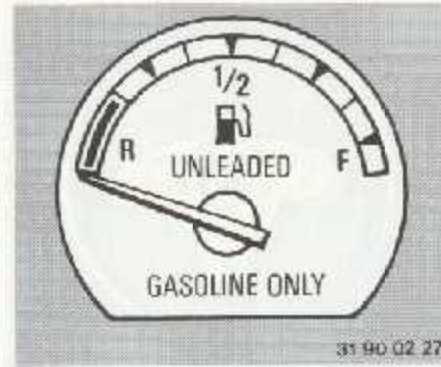

Fuel gauge

If the yellow low fuel warning light comes on, there are approx. 2.6 gal. (10 liters) of fuel left.

For a function test the light comes on shortly when the ignition is switched on. With the On-Board Computer the approximate distance of the fuel left can be displayed.

For further information: See page 47.

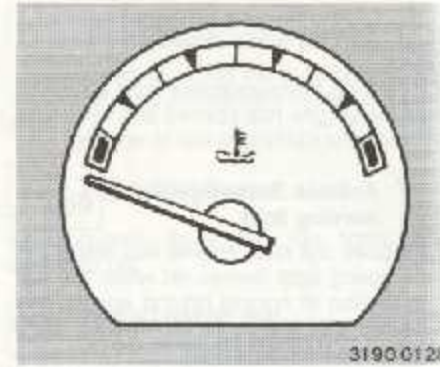

Coolant temperature gauge

Blue: Engine has not reached normal operating temperature. Drive only at moderate road and engine speeds.

Red, indication "COOLANT TEMPERATURE" in the MID: Engine overheated - pull over to a safe area out of the main-stream of traffic and stop engine immediately. Allow system to cool down until temperature gauge indicator is approx. in the middle of the scale.

Normal operating temperature is between the two colored zones. The needle may tend to reach the red zone when the ambient temperature and/or the engine load is very high.

To check coolant level: See page 81.

Ignition

0 Steering

The key moved in

To lock the turn the you hear

All items switched which re flashers, side/par seats an

1 Steering

To relea necessa slightly.

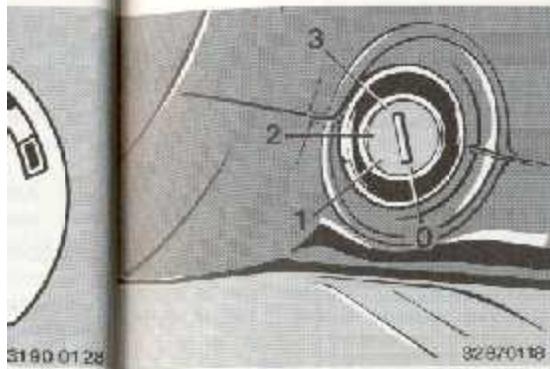

5190 0128

32970118

Ignition/starter switch

ormal op-
at moder-

EMPERA-
rheated -
the main-
e immedi-
own until
approx. in

between
edle may
the am-
ine load

81.

0 Steering locked

The key can only be inserted and removed in this position.

To lock the steering, pull out the key and turn the steering wheel to left or right until you hear that the lock has engaged.

All items of electrical equipment are switched off except for the following, which remain operational: hazard warning flashers, cigarette lighter, interior light, side/parking lights, electrically operated seats and trunk light.

1 Steering unlocked

To release the steering lock, it may be necessary to turn the steering wheel slightly.

Further equipment like radio and On-Board Computer can be operated.

2 Ignition switched on

All electrical items can be operated.

To use the comfort of the various electrical equipment, a fully charged battery is essential for their operation.

When the engine is idling, the alternator only charges the battery very slightly. We recommend switching off electrical equipment with high current consumption (e.g. seat heating, rear window defogger) unless absolutely needed when driving in city traffic.

To maintain the memory sense of some electronic equipment, a low current is always flowing. For this reason, if the vehicle is to be laid up and out of use for a long period, have the battery checked and fully charged by your BMW dealer.

3 Starter engages and cranks engine

BRAKE indicator light will illuminate during starting for a bulb check. As soon as the engine starts, release ignition key. It will return to position 2 and BRAKE indicator will go out.

On vehicles with automatic transmission please note that starting the engine is only possible in selector lever position P or N.

Starting the engine

- Pull up parking brake
- Always check first that the gear lever is in neutral before operating the starter.
- Automatic transmission cars can only be started with the selector lever at P or N.
- Turn off as many items of electrical equipment as possible to reduce the load on the battery.
- At low outside temperature, on manual transmission cars, depress the clutch pedal.
- Start the engine.

Further information:

To start the engine, turn the ignition key



At a glance

clockwise to position 3 and hold it there until the engine starts (but not longer than 20 seconds). When the key is released it will return automatically to position 2.

- If the starter has to be operated a second time, the ignition key must first be turned back from 2 to 1. This interlock has been deliberately introduced to help ensure that the starter gear does not come into contact with the flywheel gear before the engine has stopped turning.

- In very cold weather the first attempt to start the engine should not exceed approx. 20 seconds in order to limit battery discharge; if a second attempt is necessary, wait a short while (about 20 to 30 seconds), and then operate the starter again for a similar period.

Usually it is not necessary to depress the accelerator pedal. However, at high altitudes, or in very hot or very cold weather, depress the pedal halfway down when starting the engine.

Engine idle speed is controlled by the engine computer system. Increased speeds at start-up are normal and should decrease as the engine warms up. If engine speed does not decrease, service is required.

Warning:

Never run the engine in an enclosed space. The exhaust contains carbon monoxide, which, although colorless and odorless, is extremely toxic.

When leaving the car unattended, take the key with you. Make sure that the steering lock has engaged.

Never leave engine idling unattended. An unattended vehicle with a running engine is potentially hazardous.

Never pull out the ignition key when the car is moving, or the steering lock will engage (the steering may need to be turned only slightly) and render the car uncontrollable.

To prevent the battery from discharging, always switch off the consuming devices not in use, as well as the ignition when the vehicle is not being driven.

To stop the engine: Turn the ignition key back to position 1 or 0.

Break-In Information

The engine of your BMW has not been governed in any way, so that there is no restriction on its performance even when new. It is therefore up to you to ensure that the full operating life and potential economy are later achieved. This is accomplished by adhering closely to the following break-in rules.

For the first 1200 miles (approx. 2000 km), drive at varying road and engine speeds. Do not exceed 4000 rpm. And, for manual transmission vehicles in 6th gear as well as for automatic transmission vehicles, do not exceed two-thirds of the maximum road speed.

Do not use full throttle or the kick-down position of the accelerator pedal at a during this period.

During the break-in period, a degree of stiffness may be noticed when shifting gears, in the steering and other controls and mechanical assemblies. This will disappear after a short period of use and should be regarded as part of the normal break-in process.

After 1,200 miles (approx. 2000 km) have been covered, you can gradually increase your road speeds to the specified cruising and top speeds of your car, assuming that general road and traffic conditions make such speeds possible.

Engine, transmission and rear axle

Should any such assembly be replaced at a later stage in the car's life, the break-in procedure must be repeated.

Tires

The production industry allows less than 10% road surface wear and as a pattern, a strain of 300 km).

Note:

Obey your speed limit.

Warning

When driving on a road with a wedge in the tires, the tires are known to be in a partial cycle condition. Speed of

kick-down
pedal at a

degree of
en shifting
er control
his will dis
of use and
the norma

0 km) have
ly increas
ified cruise
, assuming
conditions

axle
replaced at
ie break-in

Tires

The production methods used in the tire industry result in brand-new tires having less than their designed adhesion at the road surface. Until full grip is available, and as a means of obtaining a good wear pattern, we recommend you drive with restraint for the first 200 miles (approx. 300 km).

Note:

Obey your local and state maximum speed limits.

Warning:

When driving on wet or slushy roads, a wedge of water may build up between the tires and the road. This phenomenon is known as aquaplaning and may cause partial or complete loss of traction, vehicle control or stopping ability. Reduce speed on wet roads.

Brake pads

As a means of achieving uniform wear patterns and a good friction coefficient on new pads, avoid repeated heavy brake applications, especially from high speeds, during the first 300 miles (approx. 500 km), and also prolonged severe loads such as may occur when descending long mountain passes. During the break-in period, refrain from subjecting the brakes to any form of endurance testing.

Brake pads and discs require the distance stated above and the quoted operating conditions in order to seal properly and give smooth results and maximum wear during the car's life.

Since the parking brake operates on an entirely separate brake system with its own drums, it must also be seated correctly.

During the Pre-delivery check and inspection, your BMW dealer will seat the parking brake linings correctly.

Warning:

The brake booster on your BMW is charged up only when the engine is running. When the car is moved with the engine stopped, for instance when being towed, a much higher pedal pressure than usual will be needed to produce the anticipated braking effect.



At a glance

Energy-conscious driving:

Your BMW incorporates the technical requirements for economical driving and low pollution. To make use of this, obey the following information to reduce fuel consumption and environmental pollution as well as wear to the engine, brakes and tires.

- **Do not warm up the engine at idle speed. Drive away immediately using low engine speed.**

Warming the engine up at idle speed takes a long time and also at this stage emission output is especially high.

- **Avoid long periods of engine idling.**

Engine stops for even as short as one minute can contribute to better fuel economy and reduced emissions, are savings that count.

- **Use the 1st gear only to start off. Shift up to a higher gear as soon as conditions permit and drive in more economical gears.**

Best results in fuel consumption and the lowest pollution will be achieved with low engine speeds and higher gears. Avoid driving at full throttle for long periods.

- **Do not carry unnecessary weight.**

Especially in congested city driving with many accelerations, additional weight increases the fuel consumption.

- **Remove roof and ski rack immediately after use.**

Roof racks increase the air resistance and fuel consumption, especially at high speed.

- **Check tire pressures regularly every two weeks.**

If the tire pressure is less than specified rolling resistance is increased and the fuel consumption too.

Fuel re

Opening

Push the

Opening

Turn on

Closing

stop (be

Opening

failure c

page 83

Warning

Use uni

nent sa

with ga

Never c

your v

empty,

result i

eight.
driving with
weight in

mediate

resistance
ly at high

lary even

specified
nd the fuel



Required fuel quality

Unleaded gasoline only (87 AKI* or 91 RON**).

The fuel filler neck is equipped with a leaded fuel restrictor and a check valve. The restrictor prevents the insertion of fuel filler nozzles not designed for lead-free fuel.

The check valve prevents the fuel vapors from escaping from the fuel tank.

Items to check:

Items to check:	Page
- Tire pressures (including spare tire), every two weeks	20
- Engine oil level	78
- Battery electrolyte level, filling up with distilled water	84
- Coolant level	81
- Brake fluid level	80
- Light system, bulb change	96
- Washer fluid for windshield and headlight cleanser	83



Fuel refilling

Opening the fuel filler flap:
Push the fuel filler flap (arrow).

Opening the fuel filler cap:
Turn counterclockwise and take it off.

Closing: Turn the cap clockwise to the stop (bayonet fitting).

Opening of the fuel filler flap in case of a failure of the central locking system: See page 93.

Warning:
Use unleaded gasoline only. Obey pertinent safety rules when you are handling with gasoline.

Never carry additional fuel containers in your vehicle. Such containers, full or empty, may leak, cause an explosion or result in fire in case of a collision.

* Anti Knock Index
** Research Octane Number

At a glance

Tire pressure

For your own safety – check tire pressures regularly!

Correct tire pressure is essential for your and everybody's safety. Wrong tire pressure may lead to serious accidents (no driving stability, tire destruction). Cold tire inflation pressure adequate for speeds up to 110 mph (180 km/h). For speeds higher than 110 mph (180 km/h) add 7 psi (0,5 bar). Tire pressures are in psi (bar). Check tire pressure when cold (ambient temperature).

Note:

On warm tires the pressure can rise about 4 psi (approx. 0,3 bar). Changes in temperature vary the tire pressure (e.g. 18° F [10° C] = 1,5 psi [0,1 bar]).

Radial-ply
tubeless tires

235/50 ZR 16
235/50 R 16 95 H M + S
225/55 R 16 95 H M + S

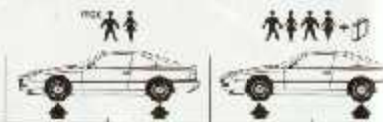

29 (2.0)	32 (2.2)	30 (2.1)	36 (2.5)
-------------	-------------	-------------	-------------

On cars equipped with a trailer hitch, increase pressures on the rear tires by 3 psi (0,2 bar) even when driving without the trailer.

When towing a trailer, use the tire pressures for heavier loads.

Your vehicle is equipped with tires which not only meet US standards, but also European standards. We recommend the exclusive use of BMW approved tires.

The quoted pressures apply to makes of tires recommended by BMW and which are known by your BMW dealer.

If other makes of tires are fitted, higher pressures may be necessary. A label showing tire pressures is attached to the driver's door post.



36
(2.5)

s by 3 ps

also Euro

which are

l showing

Automatic Stability Control (ASC)/Automatic Stability + Traction Control (ASC + T)	61
Automatic Climate Control	62
Rear window defogger	65
Glove boxes	66
Ashtray	66
Electronic Damping Control (EDC)	41
Multi-Information Display (MID)	42
Manual transmission	56
Automatic transmission	57
Automatic Cruise Control	60
Windshield wipe/wash system	38
Electric window lifts	39
Sunroof	40
Interior light	37
Hazard warning flasher	37
Fog light switch	36
Turn signal lever/Headlight dimmer switch	36
Headlight switch	36
Child restraints	35
Supplementary Restraint System (SRS)	34
Seatbelts	33
Mirrors	31
Adjustable steering column	30
Seats	28
Theft deterrent system	27
Remote control	25
Doors	23
Keys	22



Operating instructions

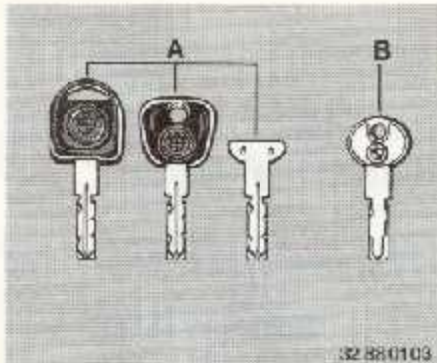

Keys

A. Master key (key for double locking system)

- Key with light and battery: press button to switch on light.
- Duplicate master key.
- Spare master key with extra-small head, to be kept in a wallet or safe place.

B. Key for doors and ignition:

Does not fit trunk or glove box and does not open the double locking system.

Note:

When locking the glove boxes, the trunk is automatically locked too.

To order duplicate keys:

The key number on the self-adhesive label is required by your BMW dealer to obtain duplicate keys; keep it in a safe place to avoid theft.

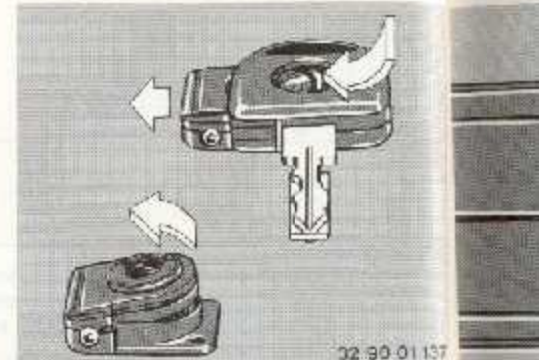

Master key with battery light

Replace the battery when the light becomes dim. Follow procedure as shown above.

Caution:

Discharged batteries may leak acid which could lead to potential damage. Use only batteries of the specified type. Avoid environmental pollution when disposing of old batteries.

Doors



Doors, locked or unlocked:
- a door
- the interior door
- the passenger door
the driver's door

As a side effect:
out of the car:
- the lock
door
- the lock
operates only

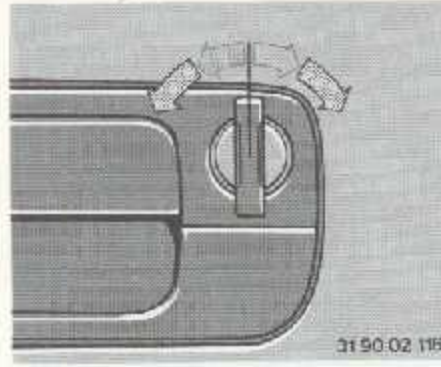

Doors

Unlocking Locking

Doors, trunk and fuel flap are centrally locked or unlocked by operating

- a door lock
- the interior lock button on the doors
- the pushbutton with the key symbol in the driver's door panel.

As a safeguard against locking yourself out of the car accidentally

- the lock button on the open driver's door cannot be pushed down
- the lock button on the passenger's side operates the central locking system only when both doors are closed.

Double lock (locking/unlocking) Theft deterrent system

To provide further protection, a double lock feature is provided. This feature works by locking all doors in such a manner that they cannot be unlocked without a key. This feature can only be activated and deactivated with a key from the outside of the doors.

To activate, turn the key in the normal locking direction past a light detent.

Let the key return to the vertical position and withdraw.

Caution:
Do not engage double locking position with passengers in the car. Without the master key for the driver's door lock, the doors positively cannot be opened either from inside or from outside.

For further details of the theft deterrent system: see page 27.

Window and sunroof operation from the door lock

To open: With closed door, turn and hold key in position open 'double locking'

To close: With closed door, turn and hold key in either position, 'central' or 'double locking'

Release the key to stop the movement.

To open a door from the outside:

Lift up the handle. At the same time, the interior light will come on (after the third operation there will be an extended delay).

Driver's side door lock heating:

Switched on when the handle is lifted. The heating interval is timed to prevent excessive battery drain.

To open a door from the inside:

First pull the interior lock button and then the handle above the armrest.



Operating instructions

Caution:

The windows automatically move down for a short distance when a door is opened and will go up again after the door is closed. This serves the purpose for easy operation, to protect the door seal and ensure a tight fit of the window in the seal.

Children left in the car could lock the doors accidentally from the inside. To avoid this, make a point of removing the ignition key and taking it with you, so that the door can always be opened from the outside.

After an accident or severe impact, the central locking system opens automatically, the hazard warning flasher and the interior light are also switched on.

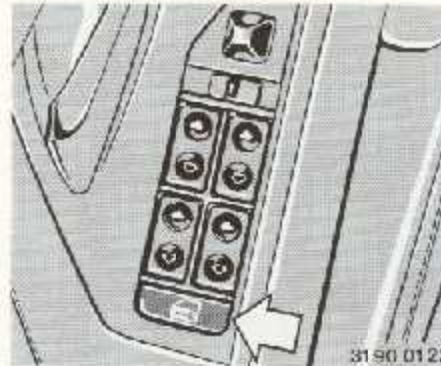

Pushbutton for central locking system

With the driver's door closed, push this button to lock or unlock the doors.

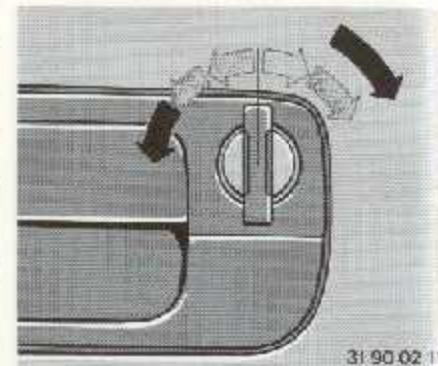

Manual locking and unlocking in an emergency

In the event of an electrical system failure (i.e. discharged battery), the car may still be unlocked or locked.

To unlock, turn the key past the normal unlock position, as illustrated.

Lock the passenger door by pushing down the interior lock button and lock the driver's door by turning the key past the double lock position.

Trunk

To open
- Unlock
- lock a
- push

For manual
electric

To close
- Push
- lock f

Trunk lid
The light
the lid

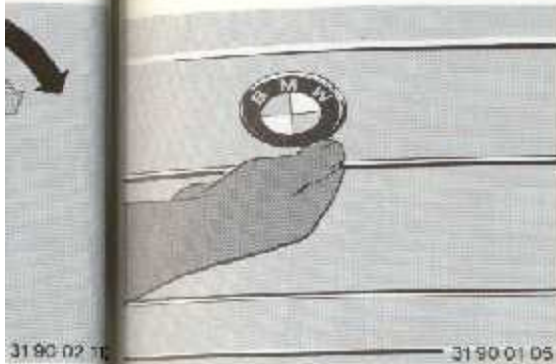

31 90 02 10

31 90 01 05

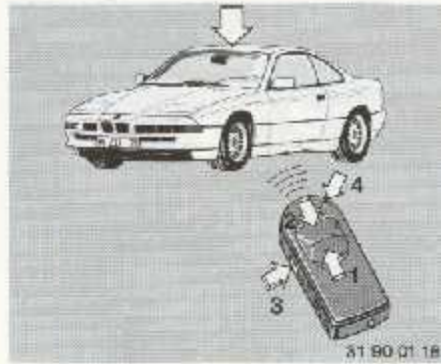

31 90 01 18

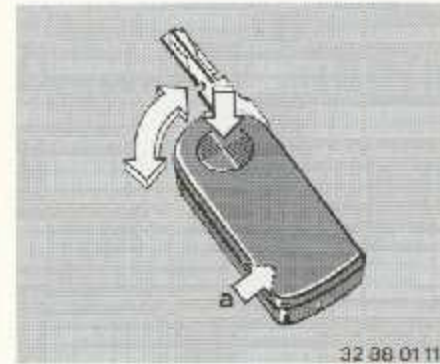

32 98 01 115



Trunk

To open:

- Unlock from a door or the glove box lock and
- push handle below trunk lid.

For manual unlocking in the event of an electrical failure, see page 93.

To close:

- Push trunk lid down
- lock from a door or glove box lock.

Trunk light

The light comes on automatically when the lid is opened.

Remote control

Point the transmitter directly to the receiver behind the car's interior mirror (max. distance 16 ft [5 m]). Avoid obstacles.

To open: Press button 1.

- Light Emitting Diode (LED) 4 lights up 5 times.
- Central locking and double lock system will be released
- Theft deterrent system is deactivated.
- The interior light is switched on.

To close: Press button 2.

- LED lights up for a short period
- Central locking system is activated and locks the vehicle.

To secure the car: Press button 3 within 15 seconds of having pressed button 2.

- LED lights up
- Double lock system is engaged
- Theft deterrent system is activated.

To close windows and sunroof: Press button 2 and hold.

- LED lights up

The closing procedure is interrupted when the button is released.

Master key

Press the button to fold the key out or retract it.

All functions on doors and trunk can also be operated with the keys shown on page 22.

Operating instructions



Battery

Renew the battery if the LED does not come on when a button is pressed and closing movements cannot be performed.

Renewing battery

Remove screw (arrow "a", page 25). Press the button and swing the cover aside. Remove screw (arrow "b").

The correct battery type and installing positions are printed on the battery holder.

Caution:

Replace the battery when the LED does not come on, otherwise acid may leak out and could lead to potential damage. Use only batteries of the specified type. Avoid environmental pollution when disposing of old batteries.

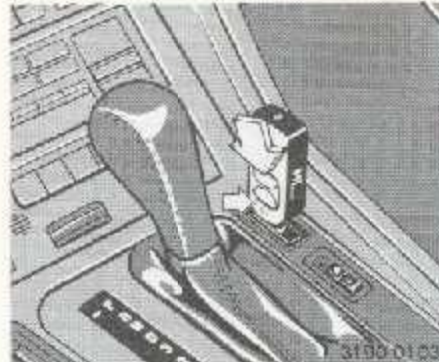

Initializing the transmitter

Transmitter initializing is necessary after renewing the transmitter battery (not necessary if this takes less than one minute and none of the buttons are pressed) **or if a new transmitter has been obtained:**

- Turn on the ignition with a second key (position 2)
- Place the transmitter on the initializing unit (see picture)
- Press button 1 until LED begins to flash (about 2 seconds) - initializing is completed

Within 15 minutes, all transmitters used for the vehicle (up to four are possible) must also be initialized. During this period do not switch off the ignition.

Changing of key blade

If the remote control unit should develop a fault, replacements without a key blade are available from your BMW dealer. To change your key blade to the new transmitter, remove the screw and take out the blade, fit it to the new transmitter and secure with the screw.

Theft c

When a...
cured o...
for 30 s...
rupted s...
erates f...
the high...
hazard...
are ma...
with th...
lery (ies...
30 seco...
made...
If the c...
sound...
The sy...
simulta...
unlock...
system...
lights u



Theft deterrent system

When attempts are made to open the secured car (doors, lids) an alarm sounds for 30 seconds, the ignition circuit is interrupted and the hazard warning flasher operates for 5 minutes. At the same time, the high beams in the light cluster and the hazard warning lights flash. If attempts are made to start the engine or tamper with the radio, glove boxes or battery(-ies), the alarm sounds for a further 30 seconds each time such an attempt is made.

If the car is pushed the alarm begins to sound after a short distance.

The system is activated and deactivated simultaneously with the operating of the unlock inhibit system. When activating the system the LED (see arrow in picture) lights up for up to 36 hours.

If the LED flashes, either a door, engine hood, trunk lid, window, sunroof or the glove box is not locked properly.

In this event, the system is activated automatically after 10 seconds and the LED lights up.

When deactivating the system, the LED goes out. When deactivating after the LED has gone out (after 36 hours), the LED flashes.

If alarm was activated, the LED flashes for up to 36 hours to indicate that the car has been tampered with.

Note:

With an activated system, the trunk may not be opened manually as done in the event of an electrical failure, because the alarm will sound.

Flashing of the LED for 10 seconds means that the trunk lid was closed but not locked. Turn the key to the right and pull it out.

Opening procedure in case of emergency:

- Open the door with the ignition key (alarm will sound),
- Close the door and turn the ignition key to position 1 (alarm will sound),
- Wait until LED goes out (approx. after 15 min.). Do not open the door during this time and leave the ignition key in position 1.

Consult your BMW dealer.



Operating instructions

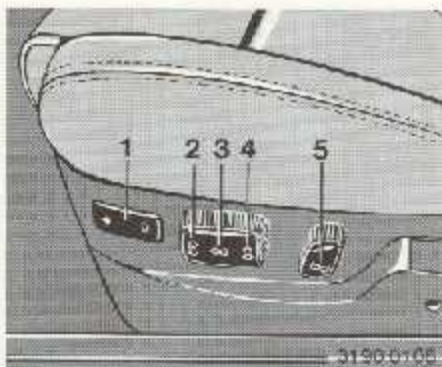

Seats

- 1 Rocker switch to adjust thigh support
- 2 Raise/lower front of seat
- 3 Move seat forward/backward
- 4 Raise/lower rear of seat
- 5 Adjust backrest angle

Headrest

The height is automatically repositioned whenever the seat is moved to a new position. The angle is varied by tilting the headrest forward or backward. For seat, mirror and steering wheel memory see page 32.

General remarks on seat position

Back muscles and spinal discs obtain most relief when you move right back in your seat and relax. Ideally the driver's head should be on a line forming a direct extension of the spinal column.

On long trips the backrest angle can be slightly increased, thereby further reducing the strain on the body muscles. Make sure that you are able to hold the steering wheel with your arms slightly bent.

Warning:

Do not adjust seat position while driving. The seat may move unexpectedly, which could cause sudden loss of vehicle control and constitutes an accident risk.

Passengers should not ride in a moving vehicle with the backrest reclined for the following reasons:

In a frontal collision the lap belt may slide past the hips and apply restraint forces directly to the abdomen, creating a risk of serious injury. The shoulder belt cannot immediately restrain your upper torso if it does not rest firmly against your body.

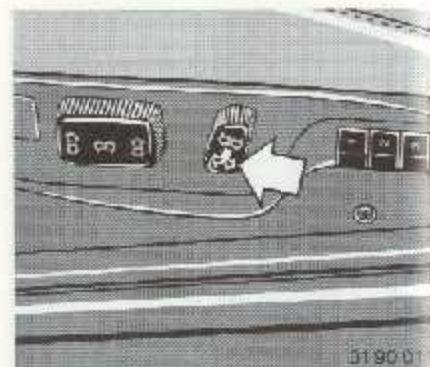

Lumbar support

The shape of the backrest can be varied to suit your desired position.

Upper pelvis and the spine will be supported for a relaxed journey.

Push switch down and shift:

- to the front: Support pad moves forward
- to the rear: Support pad moves backward.

Seat height

Seat height can be adjusted when the vehicle is stationary. To adjust the seat height, push the seat height switch down.

To change the seat height, push the seat height switch down. The seat height is not adjusted until the seat height switch is pushed up again.

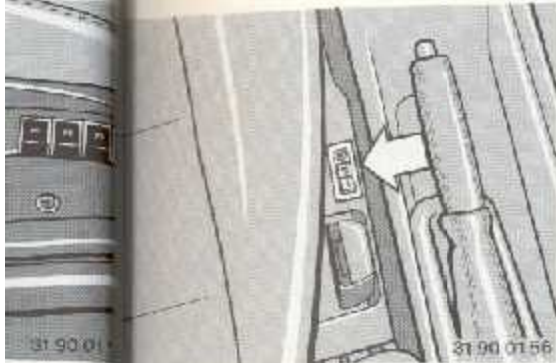

Seat heating

Seat cushion and backrest can be heated when the engine is running.

Seat heating is operated by the rocker switches with symbols:

- ☰ Seat quickly warms up as long as the switch is illuminated.
- ☒ Constant heating is on automatically.
- ☐ Heating as long as the switch is illuminated.

To change heat function while seat heating is on: Push the part of the switch that is not illuminated.

To switch off: Push the illuminated part of the switch.

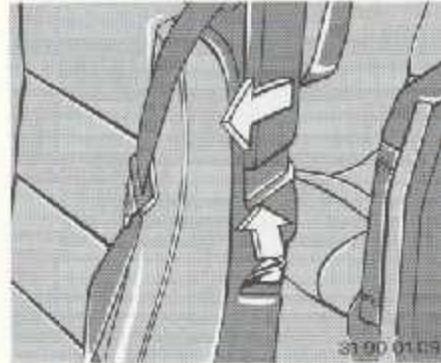

Folding backrest

Pull safety catch lever up and fold backrest forward to gain access to the rear seats.

Warning:

The protection of the seatbelt is only guaranteed when the backrest is locked. If the indication 'CHECK LEFT BACKREST' or 'CHECK RIGHT BACKREST' is displayed in the MID, the appropriate backrest is not locked. Clear the space behind the backrest, fold back and lock with an audible click.

The indication will disappear when the backrest is locked. If the indication does not disappear with the backrest locked, contact your BMW dealer.

The vehicle should not be driven if backrests are not locked.



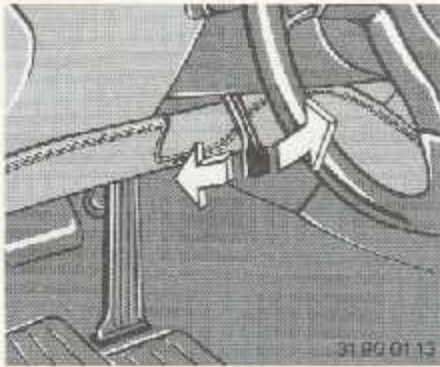

Steering wheel adjustment

- To adjust steering column, pull the clamping lever up
- Pull or push to extend or retract
- Push the lever into its recess to secure the steering column in its new position.

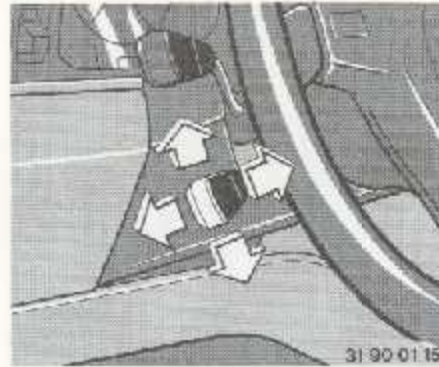

Electrical steering wheel adjustment

With the lever you can adjust the steering wheel in four directions.

Warning:
Do not adjust the steering wheel while driving.

To store suitable steering wheel positions, see memory for seat and mirror adjustment, page 32.

Automatic lift up of the steering wheel (only if memory for seat and mirror adjustment is installed).

To ease entering or leaving the car, the steering wheel tilts to the upper position if:

- The ignition key is turned to position 0.
- The ignition key is in position 1 and the driver's door is opened.
- The ignition key is in position 2, the parking brake pulled up and the driver's door opened.

The steering wheel moves in the driver's (memory) position if:

- The ignition key is in position 2 and the parking brake is released.
- The ignition key is in position 2, the parking brake pulled up and the driver's door closed.

Mirror:
Outside
Reposit
large m
Shift sm
Left - d
Right -
Both o
tioned r

wheel position
d mirror as

ng wheel
rrior adjust

the car, the
ber position

position 0,
n 1 and the

tion 2, the
the driver

n the drive

n 2 and the

tion 2, the
the driver

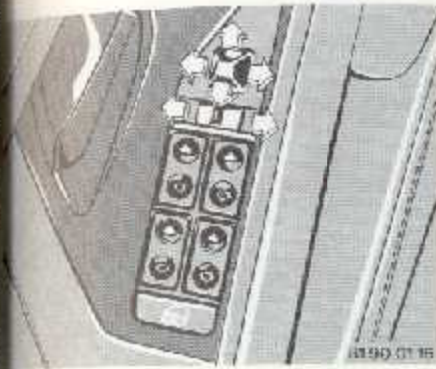

Mirrors

Outside mirror

Reposition horizontally and vertically with large mirror button.

Shift small changeover switch to:

Left – driver's side

Right – passenger's side

Both outside mirrors can also be repositioned manually by moving the glass.

Tilting the right outside mirror (only if memory for seat and mirror adjustment is installed).

The changeover switch must be in the left – driver's side – position for this function to operate.

By selecting the reverse gear of the transmission, the mirror is tilted down slightly to make it possible to see the lower part of the vehicle when parking.

Warning:

Please take into consideration that the glass of the mirror is convex. The objects you see in the mirror are closer than they appear. Do not use this mirror to estimate distance of following cars when changing lanes.

Electrically heated mirrors

The outside mirrors are heated automatically with the ignition key in position 2.

To store mirror positions in the memory for seat, mirror and steering wheel adjustment, see page 32.



Operating instructions

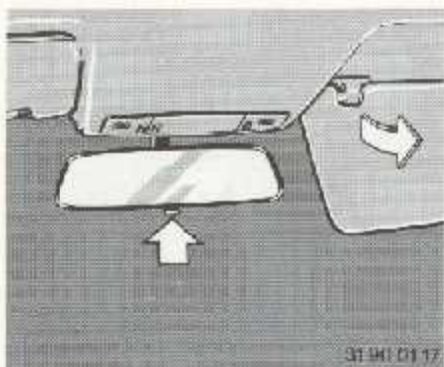

Interior mirror

The interior mirror can be moved to the anti-glare position by means of the small lever.

Sun visor

Each sun visor can also be swung around to cover the upper part of the front side window.

Illuminated make-up mirror

Swing down the sun visor with the headlights on and move the cover aside, if necessary.

Anti-glare rearview mirror

The mirror gradually darkens in the 'MIN' and 'MAX' position of the sensitivity switch to reduce glare whenever the ignition key is in position 2. As glare subsides, the mirrored glass returns to its normal position.

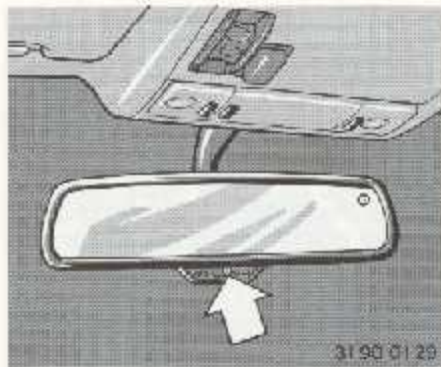

Use 'MIN' setting for city driving if your eyes are not so sensitive to glare.

Use 'MAX' setting for rural driving when distant headlights can be annoying.

In these positions when the transmission selector lever is placed in reverse (R) gear, the mirror switches to its normal position.

With the switch in 'off' position the mirror is without power and returns to its normal position.

Note:

Keep the photocells clean to ensure the operational sensitivity of the mirror.

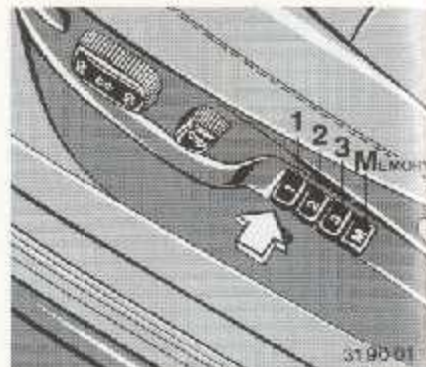

Memory for seat, mirror and steering wheel adjustment

3 different seat, mirror (both outside mirrors) and steering wheel positions can be stored in memory and recalled.

Programming:

(In ignition key position 1 and 2)

- Select the desired seat, mirror and steering wheel position by means of the appropriate switch.
- Press MEMORY button (button will be illuminated).
- Press button 1, 2 or 3. Positions are now stored in memory. Indicator light goes out.

To recall:

- Press and hold the desired button 1, 2 or 3 until the adjustment has finished.

Seatbelt

Wear your seatbelt every day with an air bag. Push the "PRESS" button.

Pull the seatbelt and buckle. Make sure any hardware is properly adjusted.

The belt should be buckled back to avoid wear.

Tighten the seatbelt.



and Seatbelts

ent
outside m
tions can b
t.

2)
mirror an
ears of th
tion will b

ositions an
The belt must fit tightly against your body; that is why you should not incline the backrest too far to the rear and should avoid wearing thick and heavy clothing.

button 1
finished.
Tighten it from time to time by pulling up the shoulder strap.

Warning:

Do not adjust seat position while driving. The seat may move unexpectedly, which could cause sudden loss of vehicle control and constitutes an accident risk.

Passengers should not ride in a moving vehicle with the backrest reclined for the following reasons:

In a frontal collision the lap belt may slide past the hips and apply restraint forces directly to the abdomen, creating a risk of serious injury. The shoulder belt cannot immediately restrain your upper torso if it does not rest firmly against your body.

Pregnant women should wear seatbelts too. The lap portion should be worn as low as possible to avoid pressure to the abdomen.

The reminder in the Check Control will be activated for about 6 seconds when the ignition is switched on. At the same time, a chime will sound. The chime will not sound if the driver's belt is put on before switching on the ignition.

The belt locking mechanism may operate:

- when taking sharp curves
- when the car is at a steep angle
- when pulling the belt rapidly
- when the car accelerates or slows down.



Supplementary Restraint System (SRS)

The Supplementary Restraint System, which consists of an airbag, the gas generator, the crash sensors and the control unit, is designed to supplement the three-point seatbelt and to provide additional protection for the driver in the event of a serious frontal accident.

A diagnostic system continuously monitors the readiness of the squib, sensors and wiring integrity of the SRS. Monitoring begins when the ignition key is turned to position 1 (and further) and continues when the car is being driven.

System is working:

The SRS indicator AIR BAG is on for about 6 seconds and goes off.

System defective:

- indicator is not on
- indicator goes off briefly after about 6 seconds and comes on again
- indicator comes on, flickers during a journey for about 5 minutes and stays on.

Have the system tested by a BMW dealer as soon as possible.

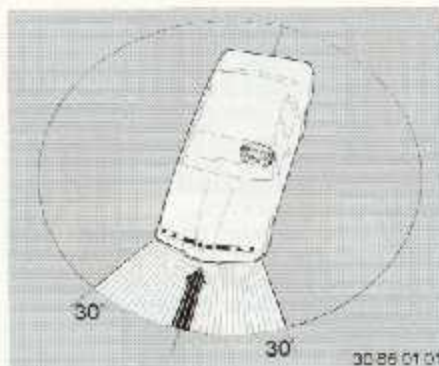

Function

The airbag is mounted under the cover in the center of the steering wheel. It is designed to inflate in a fraction of a second during frontal collisions into solid objects at speeds of approximately 12 mph (20 km/h).

During the impact a sudden, fairly loud inflation noise will be heard and a small quantity of smoke will be released, neither of which is injurious.

Since the airbag inflates with a high speed and force, a proper seating position will keep you at a safe distance from the airbag.

Do not lean with your head or chest close to the steering wheel.

Lesser impacts and those from the side and rear will not inflate the airbag, and protection will only be provided by the seatbelts.

The SRS is not a substitute for fastening the seatbelts.

In connection with the seatbelt, the SRS offers the best precondition of the protection of the body in case of a serious accident.

Tampering and improperly performed repairs can result in a failure of the system to operate or inadvertent activation.

The SRS can only be activated once. Only BMW dealers should repair or replace the system.

Do not affix any labels, decorations, badges etc. to the cover in the center of the steering wheel.

Should a SRS have to be scrapped, contact a BMW dealer for the safety precautions. If you sell your car, we urge you to inform the purchaser about the system and give him this manual.

At the date specified on the label in the glove box, please have a BMW dealer thoroughly inspect the entire SRS.

Child

All occ should cars.

Infants held on ion.

Childre depend system dent st are saf rear se tions.

Infants with a for the

Childre seatbo

Child restraints

All occupants, and especially children, should be restrained whenever riding in cars.

Infants or small children should never be held on the lap while the vehicle is in motion.

Children should sit in the rear and use, depending on age, either a child restraint system or the existing seat belts. Accident statistics have shown that children are safer when properly restrained in the rear seats than in the front seating positions.

Infants or toddlers should be secured with a child restraint system appropriate for their size.

Children six years and older may wear seatbelts.

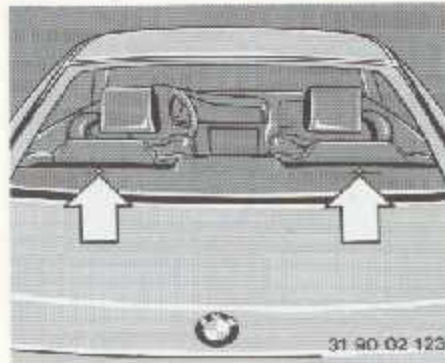

Commercially available child seats complying with the legal standard are designed to be secured with a seatbelt or with the seatbelt portion of a combination lap-shoulder belt. Because improperly or inadequately installed restraint systems can increase the risk of injury to children, always read and follow the instructions that come with the system.

If the child restraint of your choice requires the use of a tether strap, two fastening points (arrows) have been provided on the rear shelf for attachment. Ask your BMW dealer to perform the necessary work.



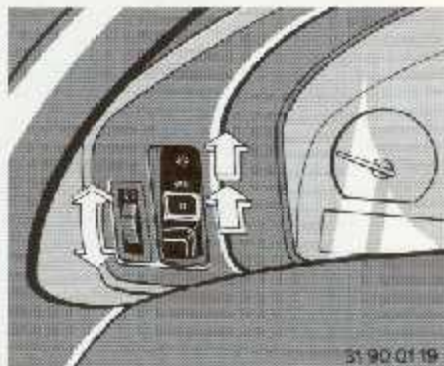

Headlight switch

- ☛ Parking lights, side marker lights switched on.
- ☛ Headlights pop up, parking lights and side marker lights are switched on when the ignition key is in position 2.

If the headlights are on, they retract when the ignition is switched off.

Canadian version

With the ignition key in position 2, the daytime running lights in the light cluster are automatically switched on.

In an emergency or in the event of an electrical failure, the retractable headlights can be popped up manually, see page 94.

Instrument light

To vary the intensity of the instrument light, turn the thumb wheel.

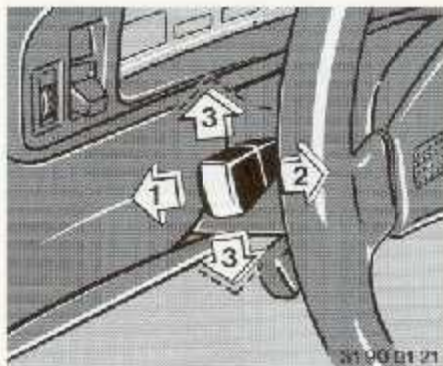

Turn signal lever/ Headlight dimmer switch

- 1 Change from low beam to high beam
- 2 High beam flasher
- 3 Turn signal

A ticking sound will be heard in the same rhythm as the turn indicators light up, to confirm that the turn signal is on.

When you return the steering wheel to the straight-ahead position, the turn signal lever will automatically cancel. However, if the steering wheel was turned only slightly, you may have to push the lever back by hand.

Brief operation of turn indicators

When pulling away from the roadside or changing lanes, you need only move the lever slightly away from its rest position. When released, it will cancel immediately.



Fog light switch

To switch on the fog lights, slide the switch up.

The headlights pop up and the fog lights are illuminated.

Whenever the front fog lights are in use, the indicator on the instrument panel comes on.

Please heed local regulations with regard to the use of fog lights.

Hazar

The haz
by the
the haz
When t
pushbu



Hazard warning flasher

The hazard warning flashers are operated by the pushbutton with the "triangle" symbol; its red warning light flashes when the hazard warning system is in use.

When the car's lights are turned on, the pushbutton is illuminated.

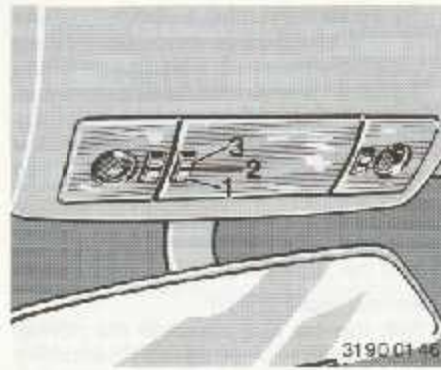

Interior light switch

- 1 Light is on:
 - When a door is opened
 - When the ignition is switched off it remains on a few seconds after the doors have been closed respectively until the ignition is switched on
 - After an accident or hard bump.
- 2 Light is permanently off.
- 3 Light is permanently on.

The map-reading lights beside the front interior lights are operated in the same way.

The interior light is automatically switched on by lifting the driver's door handle (after the third operation there will be an extended delay).

When switching off the ignition after the car's lights have been on, the interior light comes on.

After 15 minutes, any interior lights that may still be lit are switched off automatically.



Operating Instructions

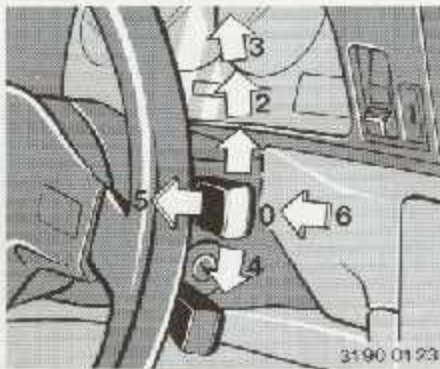

Windshield wiper/Washer lever

0 Off position

The wiper blades are resting under the hood. To put the blades vertical to the windshield (for removal). Set lever to position 1 and switch ignition off while the wiper blades are resting during the intermittent time.

1 Intermittent wipe programming

The time interval for intermittent wiping can be programmed within a range of 3 to 25 seconds (time interval will double when the car is at a standstill)

To program the interval, move the lever to position 1 and then immediately back to position 0. This action starts the timer. After the desired time has elapsed (3 to 25 seconds), move the lever fully to position 1 (stops the timer). The time interval has now been programmed. To change the time interval, bring the lever to position 0 (cancels the previous time interval) and repeat the procedure.

2 Normal wiper speed

With the car at a standstill the normal wiper speed changes to intermittent wipe.

3 Fast wiper speed

With the car at a standstill the fast wiper speed changes to normal wipe.

4 Single wipe

5 Automatic wash-wipe system

Fluid is sprayed onto the windshield and the wiper operates for a few cycles.

6 Intensive cleanser

In addition to the washer fluid intensive cleanser is sprayed onto the windshield and the wiper operates for a few cycles.

Headlight/Fog light washer

If the headlights are retracted in switch position 5 or 6, with every fifth operation the lights will be cleaned.

Note:

Do not use the washers in freezing weather without first warming the windshield with the defroster, otherwise the washer solution may freeze on the windshield and obscure your vision.

Do not operate the windshield washer when the fluid reservoir is empty. This will prevent possible damage to the washer pump system.

Washer jet heating

The windshield washer jets are automatically heated when the ignition switch is in position 2.

Electric

All window buttons
and key fob

Push the

At the
switches

Toll Circ

As an a
windows
close, a
briefly ta
resistant
while in "



Electric window lifts

All windows are operated from the push-buttons in the door panels when the ignition key is in position 2.

Push the button till the resistant point.

At the passenger's side are separate switches.

Toll Circuit

As an additional convenience, the door windows will automatically fully open or close, and the rear windows open by briefly tapping its pushbutton beyond the resistant point. To stop the movement while in Toll Circuit function, tap again.

Additionally, opening or closing is still possible after the ignition key is in position 0 or when the key has been removed and the doors have been opened once.

Window lift operation from the door lock
To open: With closed door, turn and hold key in position open 'double locking'.

To close: With closed door, turn and hold key in retract position, 'central' or 'double locking'.

Release the key to stop the movement.

Note:

After an electrical interruption (e.g. if the batteries were disconnected), the window lifts must be calibrated: Close the windows fully, or if they are closed push the appropriate button.

Automatic circuit breaker

If a window meets a resistance while closing and is more than halfway up, it will stop and retract short distance. To overcome this point (e.g. in the event of frozen windows) push and hold the button in the Toll Circuit function.

Additionally, the system is protected against a fault or overload.

Caution:

When driving with open windows and you reach the speed of approximately 90 mph (150 km/h), the windows close automatically to reduce noise. If you open a window afterwards, this function is cut off until the next engine start. Always obey state speed limits.

Warning:

The electric window lift features high pressure sealing to prevent wind noise and therefore requires powerful motors to achieve efficient closing in all conditions. Care must be taken when closing the windows to ensure that they are not obstructed.

Unsupervised use of these systems can result in serious personal injury. Before leaving the car, switch off the electric window lift mechanism by taking out the ignition key. Do not leave children unattended in the vehicle with access to vehicle keys.

Do not put anything on or near the windows that may interfere with the driver's vision.



Operating instructions

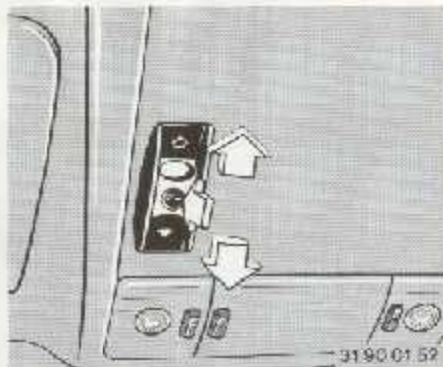

Sunroof

Operation in ignition key position 2.

To open: Push the switch to the rear.

Raising: Press the switch in the center.

To close: Push the switch to the front.

Automatic Sunroof Operation

The sunroof may be opened or closed automatically by briefly tapping the switch in the desired direction. To stop the movement, tap again. Automatic closing from the raised position is not possible.

Sunroof operation from the door lock

To open: With closed door turn and hold key in position open 'double locking'.

To close: With closed door, turn and hold key in either position 'central' or 'double locking'.

Release the key to stop the movement.

Note:

After an electrical interruption (e.g. if the batteries were disconnected), the sunroof must be calibrated: Press switch in the center or push to the front until the sunroof is fully raised.

Automatic circuit breaker

If the sunroof meets a resistance and is more than halfway closed, it will stop and retract a short distance.

Additionally, the system is protected against a fault or overload.

In the event of an electrical fault, the sunroof can be opened or closed manually, see page 93.

To avoid unpleasant drafts when driving with an opened or raised sunroof, do not close airflow outlets.

If necessary, increase the amount of airflow.

Warning:

Before leaving the car, switch off the electric sunroof mechanism by taking out the ignition key. Do not leave children unattended in the vehicle with access to vehicle keys. Use of the key can result in starting of the engine and operation of vehicle systems such as power sunroof, etc. Unsupervised use of these systems can result in serious personal injury.



Electric rear window

To move ignition...
To avoid...
does not...
below 2...

itch off th
i by taki
leave ch
cle with a
the key ca
e and ope
h as pow
se of the
is person



Electric roller sunshade for the rear window

To move the shade up or down, with the ignition key in position 2 press the appropriate switch.

To avoid damage, the roller sunshade does not operate at interior temperature below 23°F (-5°C).

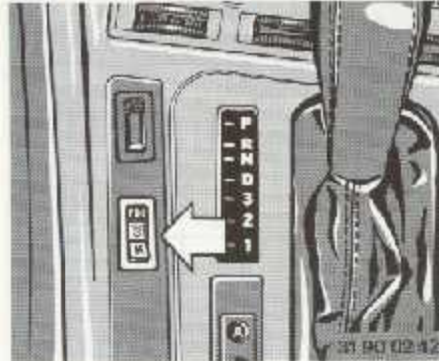

Electronic Damping Control (EDC)

The system guarantees optimum ride comfort in all driving conditions and offers additional driving safety.

Switch positions:

K – Comfort program

S – Sport program

Changing the program is always possible.

In ignition switch position 2 the selected switch position is illuminated.

The chosen program can be used over the whole speed range and for all loads. The system responds to any change of the road surface quality, operating parameter such as steering, braking and varies the damping action automatically within fractions of a second to suit the new conditions.



Operating Instructions

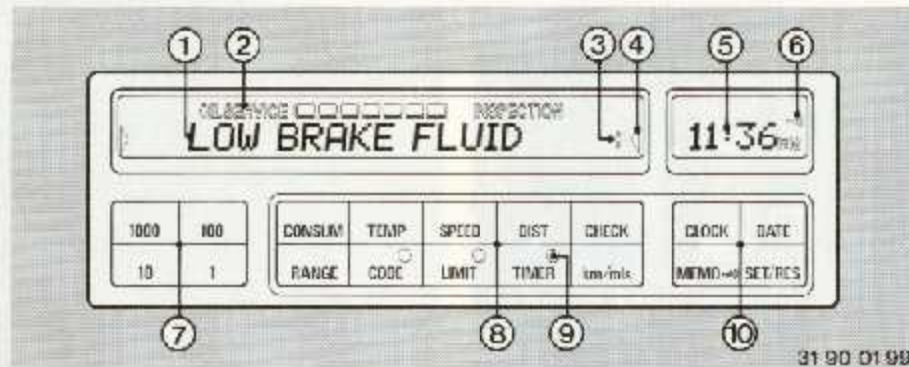

Multi-Information Display (MID)

The MID incorporates:

- The Service Indicator
- A digital clock and date display
- The On-Board Computer for information and calculation for safe and economical driving and to activate the anti-theft protection
- The Check Control

Page

- 1 Display
- 2 Service indicator
- 3 + Symbol for further information
- 4 Reminder for information
- 5 Clock and date display
- 6 Symbol for memo function
- 7 Numerical input buttons
- 8 Information buttons
- 9 Light emitting diodes (LED)
- 10 Function buttons

Further information and the operation of the systems are described on the following pages.

The following applies to all:

The memory will not accept unattainable inputs such as a 13th month etc.

When a digit is entered, the previous digit stored in the memory is erased. Digits can be changed individually and in any order.

When a button is pressed (or after each half second if the button is held), the corresponding display digit increases by one digit.

Computing is started by pressing the button SET/RES.

To delete Check Control indications press the CHECK button.

A circuit break (e.g. battery change) erases the memory. All inputs must be renewed and started.

Contact your BMW dealer if the fault display 'PPPP' appears.

Service

When the status of

Green light

As the number becomes the next

Yellow light

If the yellow light comes on

Red light

When the interval

Service Indicator

When turning the ignition on, observe the status of the Service Indicator display.

Green lights

As the number of illuminated green lights becomes less, this is an indication that the next service is due shortly.

Yellow light

If the yellow light and one of the inscriptions OIL-SERVICE or INSPECTION comes on, the appropriate service is due.

Red light

When the red light comes on, the service interval has been exceeded.

All lights go out when the engine is started.

Resetting is done after the service has been performed. For further information refer to your Service Booklet.



Operating Instructions

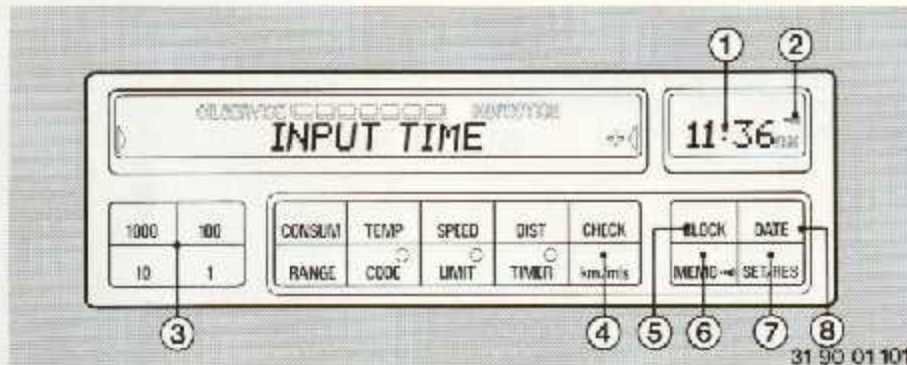

Digital clock

The clock displays time and date. A reminder can be activated.

- 1 Display
- 2 Symbol for memo function
- 3 Numeric input buttons
- 4 Changeover button for units of measure
- 5 Clock function button
- 6 Memo function button
- 7 SET/RES button
- 8 Date function button

To display time or date:

Press the appropriate button (5/8).

With the ignition key in position 0 or when the key is withdrawn, the display stays on for a few seconds. With the key in position 1 the desired display stays on constantly.

In order to obtain a 24 h and °C, 12 h and °F display, press the changeover button (km/mi) and the function button (CLOCK or DATE).

Memo function:

To switch on or off, press button MEMO. A signal will sound 15 seconds before each full hour in order to remind you – if listening to the cassette player – to switch to radio transmission for the hourly news cast. The function is indicated in the display by a sound symbol (2).

Input not
All numer
to be ma

Digits can
any order
after each
hold) the
by one.

°C, 12h
 eover butt
 tion butt
 atton MEN
 onds befo
 mind you
 ar - to swi
 hourly new
 d in the d

Input notes:

All numeric inputs for time and date have to be made as outlined in this illustration.



Digits can be changed individually and in any order. When a button is pressed (or other each half second if the button is held) the corresponding digit increases by one.

Changing time:

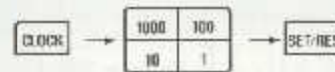

(Press CLOCK button until 'INPUT TIME' shows up in the display of the MID and the digits flash).

Changing date:



(Press DATE button until 'INPUT DATE' shows up in the display of the MID and the digits flash).

If necessary, before pressing the SET/RES button, input the year as requested. However, leap-years are programmed and adjusting is not necessary.

Inputs of time and date if the power supply was interrupted:

The clock display flashes and 'INPUT TIME' shows up in the MID display.

- Input the time and press SET/RES button to start the clock.

In the MID display, 'INPUT DATE' shows up.

- Input the date and press SET/RES button.



Operating instructions

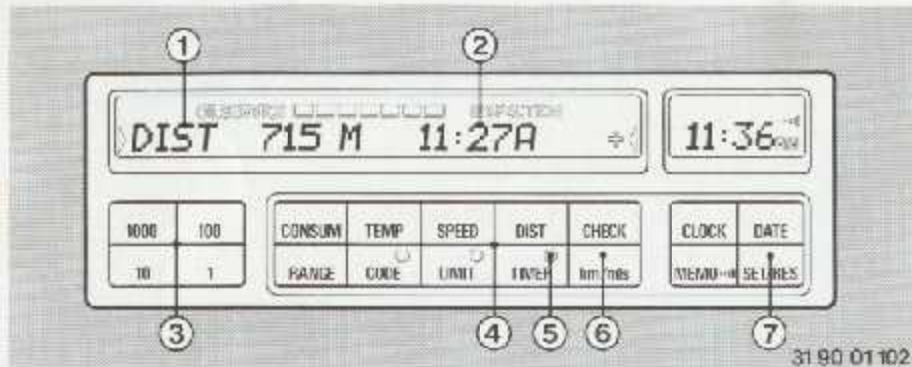

On-Board Computer

- 1 Display
- 2 Estimated time of arrival
- 3 Numerical input button
- 4 Information buttons
- 5 Light emitting diodes (LED)
- 6 Changeover button for units of measure
- 7 SET/RES button

The On-Board Computer supplies you with information for safe and economical driving.

Information without numerical input:

		Page
TEMP	Outside (ambient) temperature	47
RANGE	Range on remaining fuel	47
SPEED	Average speed	47
CONSUM	2 average fuel consumption readings	48

Information with numerical input:

		Page
DIST	Distance from destination	48
LIMIT	Speed limit warning	48

The following systems are controlled by the On-Board Computer:

		Page
TIMER	Stopwatch, 2 switch-on times for parked car ventilation	50
CODE	Vehicle immobilization for anti-theft protection	51

The On-Board Computer is ready for use at ignition key position 1 and beyond.

For safety reasons, always input information before beginning a trip with the vehicle at a standstill.

Recalculation beginning from start of trip when SET/RES button is pressed.

To call up information in the display, use also the remote control, see page 52.

Use the changeover button km/mph for units of measure to display metric or English units.

Note:

Information from the Check Control will delete this from the On-Board Computer.

Outside

Press Temperature (+3°C) measure

The war ture ha least on dropped

Warning The ou indicat ice can tures al

controlled
Pa

th-on
ar

tion
ction
ready for u
beyond.

put inform
with the ve

t start of
ssed.

display,
page 52.

km/mis
etric or E

Control
d Comput

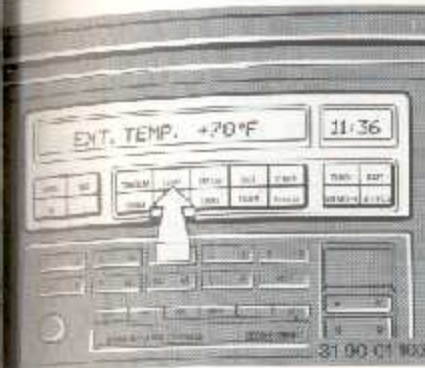

Outside (ambler.) temperature

Press TEMP button to display the temperature. Automatic display below 37.5°F (+3°C). A chime sounds and unit of measure flashes for 8 seconds.

The warning appears again if the temperature has increased to 43°F (+6°C) at least once since the last warning, and has dropped below 37.5°F (+3°C) again.

Warning:

The outside temperature display is no indicator for possible ice on the road. Ice can form or remain even at temperatures above freezing.



Range

Display of estimated distance which can still be covered with the remaining fuel, depending on driving style.

Press RANGE button to display the computed value.

A plus sign(+) in front of the display indicates a distance that will be corrected (measuring tolerance).

The flashing three-segment display indicates that fuel is urgently required. The distance is below 9 miles (15 km).

Refilling is only registered if more than 1.3 gal. (4 liters) are added and the ignition is switched off.

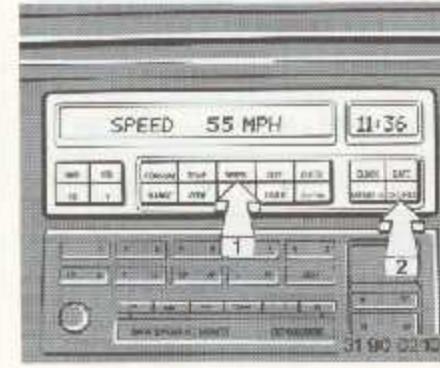

Average speed

Press buttons as shown to start calculation from start of trip.

Press SPEED button to display the average speed when other information is being displayed.



Operating instructions

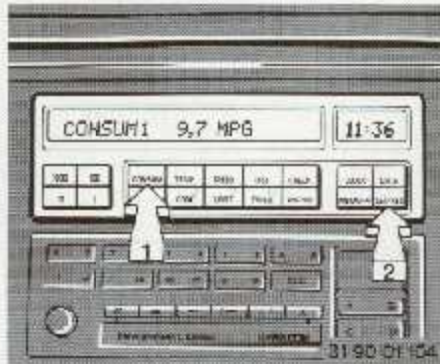

Average fuel consumption

2 readings can be calculated simultaneously, e.g. for the entire trip and part of it.

Press button as shown to start calculation from start of trip.

For the second reading press buttons again

Press CONSUM button to display the average fuel consumption when other information is being displayed. Press again to display second reading.

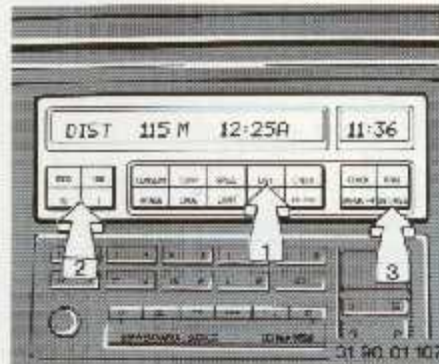

Distance to destination

The distance to the preset destination will be computed.

Press buttons as shown to input data and start the computer.

Press DIST button to display the distance to destination when other information is being displayed. At the same time, the estimated arrival time appears in the display. If the programmed distance has been completed, the counted value is accompanied by a minus sign (-).



Speed limit warning

Press button as shown to start. LED comes on.

If the preset input speed is exceeded, the LED flashes and a chime sounds. The limit value appears briefly in the display.

The warning appears again if the car has slowed down 3.1 mph (5 km/h) below preset limit and if the preset limit has been exceeded again.

Press LIMIT button again to switch off the speed limit warning. LED goes out, but

the speed is maintained.

To input data in the menu button is used.

the speed value in the memory is retained.

To input the speed at any given moment to the memory, press LIMIT and SET/RES button successively.



start. LED

ceeded t

rounds. Th

e display.

the car h

m/h) bel

et limit h

witch off t

es out, b

Operating instructions

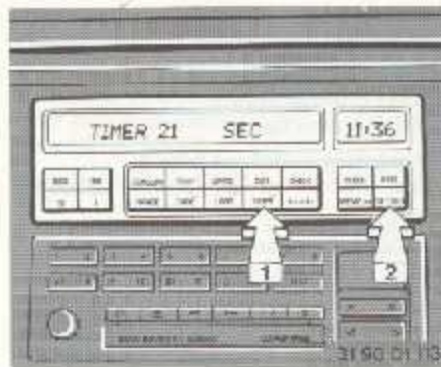

Stopwatch

There is no stopwatch function in cars equipped with the independent heater/ventilation system. The maximum time that can be measured is 99 hours and 59 minutes. The time display shows seconds and tenths of a second for the first minute, then minutes and seconds, and hours and minutes after the first hour.

Press button as shown to start. LED comes on.

To stop when the running time is in display: Press SET/RES button.

When different information is in the display: Press buttons as shown.

To take an intermediate time: Press TIMER button. LED flashes and the time will be displayed. The stopwatch continues to run.

Press the TIMER button again to recall the running stopwatch display.

Note:

The stopwatch is stopped in ignition key position 0 and restarted in position 1.



Operating Instructions

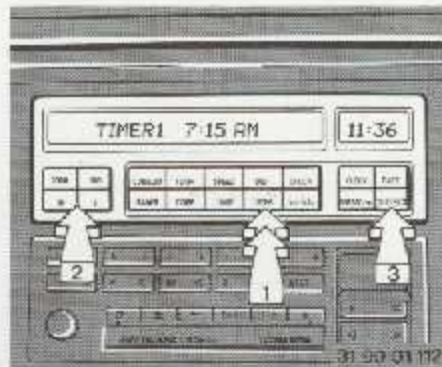

Parked car heating/ventilation

Programming of switch-on times

2 switch-on times can be preset. The function depends on the outside temperature: Heating only below 60°F (16°C), ventilation only above 60°F (16°C). The systems will run for 30 minutes from the selected switch-on time.

For further information on the heating and ventilation system, see page 62.

When you press the TIMER button, the current status is displayed.

Inputs are only possible with the clock working and the ignition key in position 1.

Programming switch-on time 1:

Press button as shown.
(TIMER button twice)

Programming switch-on time 2:

Press button in the same sequence again.

To update or change a time:

Press button as shown and change inputs.

After the input, a * is displayed and the LED comes on. During the period of operation, the LED flashes. It goes out when the system is switched off.

The selected switch-on times (1 or 2) can be activated or de-activated:

Press TIMER button, select switch-on time 1 or 2 and start by pressing the SET/RES button.

To display a programmed time:

- For the switch-on time 1 press TIMER button twice
- For the switch-on time 2 press TIMER button three times.



Immediate switch-on

Turn ignition key to position 1 and press button as shown.

Immediate switch-off

Turn ignition key to position 1 and press button as shown.

With the ignition key in position 0 press only SET/RES button.

Anti-theft

When the engine attempts to

The system code number ing the rpartment has been code num

To activate

Press but Code num input. (Fo be input).

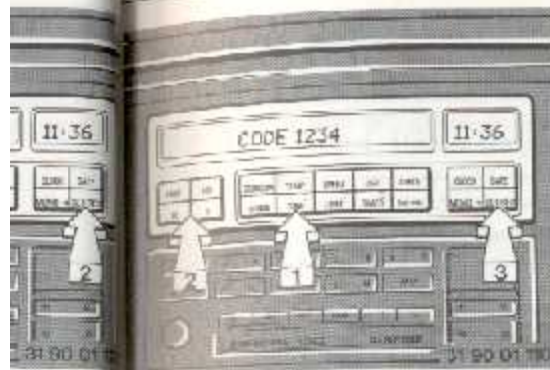

Anti-theft protection

When the system has been activated, the engine compartment lid, radio and any attempts to start the engine are monitored.

The system is activated by inputting the code number. Starting the engine, removing the radio or opening the engine compartment is only possible after the code has been input. Therefore: **Memorize the code number.**

To activate in ignition key position 1:
Press buttons as shown.

Code numbers from 0000 to 9999 can be input. (For each activation a code has to be input).

In ignition key position 0 or when the key is withdrawn, the LED comes on for 36 hours. If the LED flashes for 10 seconds, this means the engine compartment is not properly closed or the radio has been removed.

De-activating in ignition key position 1 or 2:

The chime sounds and in the display appears 'Code ----'.
- Input code and start engine, or press SET/RES button.

If attempts are made to start the engine and the system is not de-activated with the code, the chime sounds and the engine will not start.

Note:

If three incorrect inputs are made consecutively or three attempts are made to start the engine, an alarm sounds for 30 seconds.

Emergency starting procedure if the code has been forgotten:

- Disconnect and (after 5 minutes) reconnect the battery.
- Turn ignition key to position 1, the alarm sounds and in the display the time will run down to zero in 15 minutes.
- After 15 minutes, the engine can be started.

During this waiting period of 15 minutes the code can be entered! Press buttons as shown.



Operating instructions

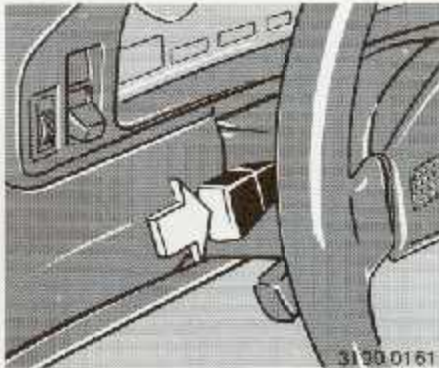

Remote control

By pressing the turn signal lever in the direction shown, the programmed On-Board Computer information can be displayed.

Note:

The display of the Check Control warnings takes priority over the information from the On-Board Computer.

Input of limited information:

- Press lever in until the Prog 1 display appears.
- Press desired information buttons consecutively. With each input the Prog number increases.
- Press SET/RES button.

If you wish to have all information displayed:

- Press lever in until Prog 1 is displayed.
- Press SET/RES button.

If the average fuel consumption reading 1 or 2, or the switch-on times 1 or 2 are to be displayed, proceed as follows: Press information button (e.g. AVG MPG) and to select the 1 or 2 reading, press km/mis button.

Each time the km/mis button is pressed, the reading will alternate.

To display:

Tap the lever for each display requested.

Check

Warning
the dis
same t
the inst
indicati

- 1 Remi
- 2 Dispi
- 3 + sy
- 4 CHE

The sy
three p



31 90 01 100

Check Control

Warnings and malfunctions are shown in the display. A chime will sound at the same time. In addition, a warning lamp in the instrument panel comes on when an indication is displayed.

- 1 Reminder symbol
- 2 Display
- 3 +symbol for further indication
- 4 CHECK button

The systems checked are divided into three priorities.

Priority 1

These malfunctions are indicated immediately, accompanied by a chime and the flashing reminder (1) symbol. If more than one occurs at the same time, the displays are shown in succession. These displays cannot be cleared by the CHECK button (4).

PARKING BRAKE

Displayed after moving off.

BRAKE ASSIST INACT.

A greater force than usual must be applied to steer and brake the car. No braking and steering assistance. See pages 80, 81.

BRAKE LIGHT CIRCUIT

Bulb, fuse or circuit defective. See page 86, or consult BMW dealer.

BRAKE LIGHTS FAILURE

Bulbs or fuse defective. See page 97, or consult BMW dealer.

LOW BRAKE FLUID

Level too low. See page 80.

Warning:

Driving with the indication **LOW BRAKE FLUID** can cause in an accident.

Have your brake system checked immediately.

ENGINE OIL PRESS LOW

Oil pressure too low, stop immediately and switch off engine. See page 12.

COOLANT TEMPERATURE

Coolant temperature too high, stop immediately and switch off engine. See pages 14, 81.

CHECK LEFT BACKREST

CHECK RIGHT BACKREST

Driver or passenger seat backrest not locked.

Fold backrest back (provide sufficient room behind the seat) until it locks in place.

Warning:

Seatbelt protection is only provided with the backrest locked in place.

The vehicle may not be driven if backrests are not locked. Contact your BMW dealer.



Operating instructions

CHECK BACKREST LOCK

Sensor or circuit for the locking control defective. Consult your BMW dealer.

Priority 2

These indications are displayed in ignition key position 2 (faults from priority 1 are displayed automatically). After the display has disappeared, the reminder symbols come on. If the + symbol appears, press CHECK button to call up further indications.

TRUNK LID OPEN

Displayed after first moving off.

1 BRAKE LIGHT FAIL

One bulb defective. See pages 97, 98.

LOW BEAM FAILURE

PARKING LIGHT FAIL

TAIL LIGHT FAILURE

F/FOG LIGHT FAILURE

R/FOG LIGHT FAILURE

LIC PLATE FAIL

Bulb, fuse or circuit defective. Consult your BMW dealer. See pages 86, 89.

TRANS FAIL-SAFE PROG

Automatic transmission: electronic shift control has failed. See page 57.

BRAKE LININGS

Worn out. See page 80.

WASHER FLUID LOW

Fluid level too low. See page 83.

Priority 3

These indications appear after stopping the car and the ignition key is in position 0. If there are several indications, they will be displayed one after the other in the sequence: priority 3, then 2 and 1.

Before taking off you can display outstanding indications by turning the ignition key to position 2. The display disappears a short time afterward, leaving no reminder symbols.

The next display won't appear until the ignition key is put into position 0.

When the + symbol appears, call up further indications by pressing the CHECK button.

CHECK
Oil level
ble. See

83.

CHECK ENGINE OIL LEV

Oil level too low. Fill up as soon as possible. See page 78.

ter stopp
s in posit
ons, they
or in the
1.
display o
ng the ig
splay dis
, leaving

until the
1.
call up fo
the CHEC

LIGHTS ON?

Displayed after pulling ignition key out and opening the driver's door.

KEY IN IGNITION LOCK

The chime sounds to remind you to pull out the ignition key before leaving the car.

FASTEN SEAT BELTS

The chime sounds to remind you to fit the seatbelt.

Note:

If the indication "SEE OWNER'S MANUAL" shows up after an indication was displayed, there are further hints given in the Owner's Manual.

Displays of the Check Control are printed in **bold letters** in the index.

Checking the function of the display (only if there is no fault displayed): With the ignition key in position 2, press CHECK button:

"CHECK CONTROL OK" should appear.



Operating instructions

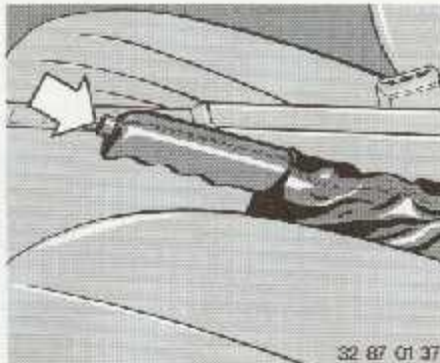

Parking brake

To set:

Pull the lever up to prevent the vehicle from moving when parked. The indicator in the instrument panel will come on.

To release:

Pull the lever up slightly, press the knob in and push the lever down. The parking brake operates on the rear wheels.

When using the parking brake while driving, apply parking brake lightly to avoid break-out.

Caution:

The stop lights will not come on when using the parking brake.

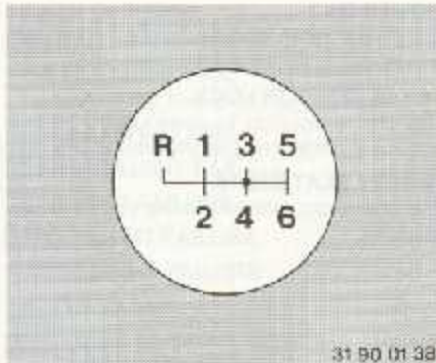

Manual transmission

The gear lever's neutral position is between 3rd and 4th gear (dot on the shift pattern). When shifting the gears, the lever automatically slips into neutral position.

All gears have synchromesh.

Caution:

When shifting gears 5 and 6, make sure the lever is pushed and held to the right to avoid shifting accidentally into the 3rd or 4th gear.

When you reach in the 6th gear engine speeds higher than 5,000 rpm, do not shift back to the lower 5th gear to avoid engine damage.

Reverse gear

Select reverse when the car is at standstill. Push to overcome the light resistance.

Backup lights

These lights come on with the ignition on and reverse gear is selected.

Caution:

Do not use the gearshift in place of the parking brake. Premature clutch wear will occur when holding the car on a steep hill with the clutch pedal partially depressed.

Automat

The follow
available p
lic condit

The lever
by symbol
On the ele
three shift
selected.

A (Autom
M (Manus

S (Sports

Engine sta
P or N.

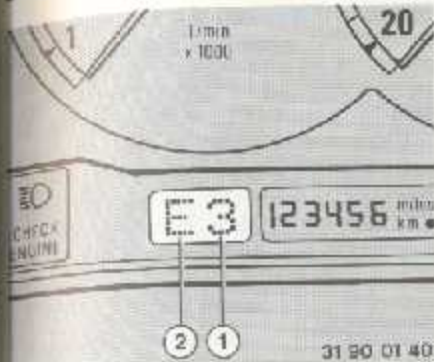

Automatic transmission

The following selector lever positions are available and displayed (1) for various traffic conditions.

P-R-N-D-3-2-1

The lever position selected is also shown by symbols on the selector lever gate.

On the **electronic-hydraulic transmission** three shift programs (display 2) can be selected. See also page 59.

- A (Automatic/Economy) – push switch to desired direction
- M (Manual)
- S (Sports) – shift lever to position 3

Engine starting is only possible in position P or N.



Note:

To move the selector lever out of position P or N when the engine is running (engine speed below 2.500 rpm, road speed below 3 mph (5 km/h), apply the foot brake. If immobilized in snow or sand, a time delay in the Shift-Lock feature enables the transmission to be quickly shifted between the D and R positions in order to "rock" the vehicle.

Pull up the release catch below the lever handle if necessary.

After selecting any lever position wait for the transmission to engage especially at low temperatures (slight drop in engine speed) before accelerating.

The car tends to crawl if the engine is running at idle speed and a drive gear is engaged.

Before leaving the car with the engine running, first select P or N at the selector lever and apply the parking brake.

P = Park

Select only when the car is standing still. The transmission is locked in this position as an additional precaution against rolling away. Press the release catch at front of the selector lever handle before engaging this position.

R = Reverse

Select only with the car standing still and the engine idling. First press the release catch at front of selector lever handle.

N = Neutral

There is no connection between the engine and the transmission. Select this position during prolonged periods of idling (for instance in traffic jams). Apply the foot brake to prevent unintentional rolling of the car.

At short stops, for example, when waiting at traffic signals, the drive position should be left in engagement.

To prevent excessive clutch plate wear, do not select neutral when driving the car unless absolutely necessary (e.g. to prevent skidding).

Operating instructions

If it happens accidentally, release the accelerator immediately and select the new position.

D = Drive (automatic gear selection)

This is the position for all normal driving. The car starts in 1st gear and shifts up automatically.

The shift points are chosen for maximum economy. In the 4th speed range, the converter lockup clutch engages automatically, depending on speed, and thus creates a mechanical link between the engine and transmission.

The 4th speed range is designed as an overdrive, to reduce engine speed, engine noise and fuel consumption once a steady road speed has been achieved.

The 4th gear is not selected when the accelerator pedal is depressed beyond the full throttle position (kick-down).

3 = S program, direct drive position (display 2 shows S)

This is the program for an enthusiastic driving style. The gear shift points are delayed to make full use of the car's power reserves. The converter lockup clutch engages automatically in 3rd gear.

If increased performance is needed, shift to this range.

If – in D = Drive – under certain city or highway driving conditions repeated gear changing between the ranges 4-3-4 occur, shift to this position.

2 and 1 = Hill-climbing and engine braking

These positions may suit the driver better on mountain roads or very long uphill and downhill gradients. It makes better use of full engine performance and the engine's braking effect.

Positions 2 and 1 can be selected at any speed, after releasing the safety catch at the front of the handle. However, the transmission will not shift down immediately into 2nd and 1st because this would cause excessive engine rpm.

Note that once position 2 or 1 has been selected, the transmission will no longer shift up to a higher speed range, even if this means that the engine speed can become excessive.

"Kick-down"

After reaching the normal full-throttle position, the accelerator pedal on automatic transmission cars can be depressed further by overcoming the detent.

This will enable maximum acceleration to be obtained immediately by selection of lower gears.

After the kick-down has been operated, the upward shift will occur only at a much higher engine speed than usual.

For towing and starting with a dead battery, see page 88.

Progr hydra

A = E (displa

Once 1
gram
fuel-co
verter
ally in

Econo
when :

M = 1

This p
(3rd g
lected
examp
1 and
no ur
take p
icy ro
In pos
and n

lected at a safety catch. However, in an emergency, the driver can immediately disengage this warning.

The 1st gear has been selected. The vehicle will no longer change, even if the driver's foot is on the accelerator. The maximum speed can be limited.

The throttle is controlled automatically. The driver can press the accelerator pedal if necessary.

The acceleration selection is automatic.

The driver can operate the vehicle at a maximum speed.

The driver can operate the vehicle at a maximum speed.

Program switch for electronic-hydraulic transmission

A = Economy program (display 2 shows E)

Once the car has been started, this program is automatically selected for low-fuel-consumption motoring. The converter lockup clutch engages automatically in 3rd and 4th gears.

Economy mode is automatically selected when starting the engine.

M = Manual program

This program is for single-gear driving (3rd gear if D is selected). The gear selected is also used for pulling away. For example, if the selector lever is in position 1 and you are driving up steep gradients, no undesirable upward gear shifts will take place. The same applies to driving on icy roads in winter: with the selector lever in position 3, you can pull away smoothly and no gear shifts will occur.

Display "TRANS FAIL-SAFE PROG" in MID:

Electronic shift control has failed.

If the failure message appears and the vehicle is moving, the 4th gear will be selected.

The 3rd gear for better performance will be selected and held when the vehicle is stopped, the engine switched off and then on again.

In this event avoid extreme engine loads and consult the nearest BMW dealer.

Caution:

Before leaving the car make sure the gear selector lever is engaged in P (Park) and set the parking brake.

Unexpected and possibly sudden vehicle movement may occur if these precautions are not taken.

Never have any driving position engaged when checking under the hood.

Never leave children unattended in the vehicle.

For towing and starting with a dead battery, see page 88.



Operating instructions

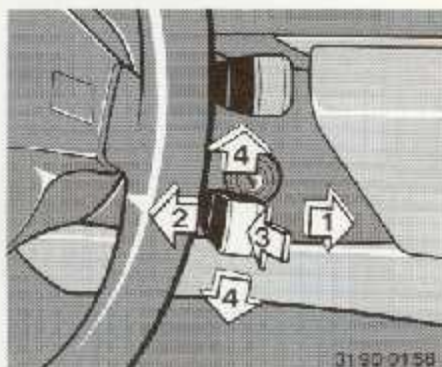

Automatic Cruise Control

This system allows adjustment for a constant cruising speed in the speed range above **25 mph (40 km/h)**

1 ACCELERATE

Tapping the lever: Speed will be held and memorized. With each tap the speed increases approx. 0.7 mph (1 km/h).

Holding the lever in this position: Your vehicle accelerates without using the accelerator pedal. After releasing the lever the achieved speed will be maintained and memorized. The controlled speed will be interrupted and has to be resumed if the memorized speed has exceeded 7 mph (10 km/h) for longer than one minute.

2 DECELERATE

Holding the lever in this position: Your vehicle decelerates automatically if cruising with controlled speed.

After releasing the lever the achieved speed will be maintained and memorized. Tapping the lever: Decelerating for approx. 0.7 mph (1 km/h) when cruising with controlled speed.

3 RESUME

Tapping the lever: The last memorized speed will be achieved and maintained.

4 OFF

By tapping the control lever the cruise control can be switched off in any driving and operating condition.

The "memorized" speed is canceled by switching off the ignition.

However, the controlled speed will be interrupted:

- When it is exceeded by 10 mph (16 km/h)
- when it is decreased by 5 mph (8 km/h)
- if the deceleration is more than 5 ft/s/s e.g. on steep upgrade,
- when using the footbrake, the clutch or moving the gear selector lever from D to N.

Warning:

Only use the automatic cruise control if the traffic and weather conditions make it advisable to travel at a steady, constant speed.

Never use the automatic cruise control if:

- you are in heavy traffic
- the road is winding and where a constant speed cannot be maintained
- the road surface is slippery - rain, snow, ice
- the road surface consists of a loose driving surface - gravel, dirt, sand.

Auto Auto Tract

Both :
partic
corner
They a
optim
even i
favor
The s
matic
The in
goes
To sv
light



**Automatic Stability Control (ASC)
Automatic Stability +
Traction Control (ASC + T)**

Both systems increase the car's stability particularly when accelerating or when cornering.

They avoid rear wheel slipping and ensure optimum traction of the driven wheels, even if driving and road conditions are unfavorable.

The systems are ready for operation automatically whenever the engine is started.

The indicator light in the instrument panel goes out.

To switch off: press button, the indicator light comes on.

To re-activate:

Press button again, the indicator light goes out.

Indicator light flashes:

The system is active, slipping wheels trigger the device to influence the amount of power transmitted to the driving wheels.

Indicator light stays on after the engine has started or comes on while driving:

System has developed a fault, the vehicle can still be driven normally. Consult a BMW dealer.

Function

Highly responsive sensors detect the wheel rotating speeds. If a difference is detected, the system automatically reduces engine power output. On vehicles equipped with ASC+T the driven wheels are also braked if necessary.

Note:

However, even a car with ASC/ASC+T is subject to the normal physical laws, so that the driver must still avoid speeds at which tire grip cannot be maintained or lateral forces become too high. It would be irresponsible to misuse the additional safety margin which ASC/ASC+T can provide in certain circumstances to drive at the very limit of the car's performance when this would constitute a self-evident safety risk.

If not all the tires are of the same pattern, ASC/ASC+T may react oversensitively. Only fit tires of the same make and tread pattern.

The ASC/ASC+T system can be switched off and the car's driveline allowed to operate conventionally. It is also advisable to switch it off when trying to rock the car out of deep snow or a soft surface (see "Winter operation") and when snow chains are fitted.



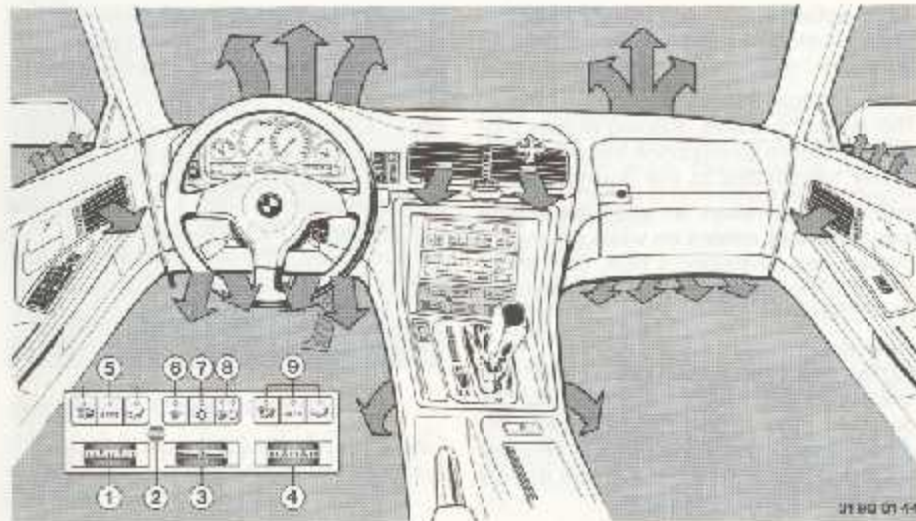

Automatic Climate Control

- 1 Rotary temperature control, driver's side
- 2 Air intake for temperature sensor – do not cover
- 3 On/off switch and rotary blower control
- 4 Rotary temperature control, passenger's side
- 5 Program pushbutton for air distribution on the driver's side
- 6 Pushbutton for maximum defrost settings for front, side, and rear windows

- 7 Pushbutton for air conditioning
- 8 Pushbutton for Automatic Recirculated Air Control and/or recirculated air
- 9 Program pushbutton for air distribution on the passenger's side

With the system switched on (rotary blower control in minimum position), when pressing a pushbutton its corresponding LED will come on.

Rotary temperature control, driver's and passenger's side

The temperature scale acts as a guide when selecting a pleasant interior temperature. The chosen setting will be reached soon after starting a trip and no further adjustments should normally be necessary.

To prevent undesirable fluctuations in temperature, alter the setting in small stages only.

In the full warm or full cool positions there is no automatic temperature control on either the driver's or passenger's side. In case of an electronic failure, these positions provide emergency operation.

Rotary blower control

Position 0: System switched off, no air admission: turn the rotary switch to the detent position for a low blower speed. Turn the switch to the right to increase the volume of air supplied to the car's interior.

Program pushbutton for air distribution on the driver's and passenger's side.

Automatic air distribution depending on the temperature conditions

Using this program will satisfy most demands for a pleasant interior temperature.

Depending on conditions, the air is opened and closed. For stratification-free operation, the outlets are varied. See To obtain the best system, do not rotate the rotary blower past the de



This program is for weather, or at the low

Note: If under a shield and the button 6) is pushed and it will reduce the

control,
driver's side

as a guide
for temper-
ature reach-
ing no furth-
er be neces-

uations
in sm

tions the
control
driver's side
these posi-
tion.

off, no
itch to the
speed.
to increas-
the car's

air
driver's and

in
temperature

most de-
temperature

Depending on the temperature conditions, the outlets for air admission will be opened and closed automatically.

For stratified temperature pattern and fatigue-free driving, the air entering through the outlets at the instrument panel can be varied. See next page.

To obtain maximum performance of the system, do not close all air outlets. The rotary blower switch should be turned past the detent position.

 **Air distribution through all outlets – no automatic air distribution**

This program should be selected if, in hot weather, cooling and ventilation especially of the lower regions of the car is desired.

Note:
If under certain circumstances the windshield and side windows start to fog up and the maximum defrost setting (pushbutton 6) is not requested, press this button and increase blower speed. Also reduce the airflow at the outlets.

 **Air distribution only through footwell outlets**

The defroster outlets are only slightly opened.

This program should be selected if, in cold weather, no air admission is desired and if you want the footwell area to be heated quickly.

Note:
After a cold start at low outside temperatures and until the heater reaches a temperature of 86° F (30° C), air distribution in all programs takes place only through the defroster outlets.

 **Pushbutton for maximum defrost.**

Depending on drying settings for front, side and rear windows press button for automatic defrosting. This pushbutton overrides all present settings.

Maximum effect is not obtained until the engine has reached its normal operating temperature.

If the windows fog over, this is caused by temperature difference (condensation) or by high atmospheric humidity. The only cure is to dry the glass by increasing the flow of air and its temperature. Pressing the button again will restore the previous settings automatically.

Note:
When this button is first pressed after the engine has been started, the rear window defogger is also in operation.

 **Pushbutton for air conditioning**

When pressing this pushbutton, the air conditioning operates, in both the heating and cooling programs, above a temperature of 33° F (1° C).

To suit your needs, the air will be cooled and dried or only dried.

In exceptional cases, for instance if atmospheric humidity is extremely high, it is best to run the air conditioning without delay (before moisture condensate can reach the evaporator) to dry the air and prevent the windows from fogging over.



Operating instructions

When cooling with maximum power the system is switched to recirculated air automatically (with little fresh air admission).



Pushbutton for recirculated air

This program should be selected when outside air is polluted – fresh air flow from outside is cut off, inside air is only recirculated.

Although the air conditioning is switched on automatically, this position should not be used too long, as the air quality inside the car gradually deteriorates.

Note:

Should the windows fog over with this program, press button again and switch the air conditioning on.



Pushbutton for Automatic Recirculated Air Control (AUC)

Press button subsequently to select three functions which are monitored by the LED's.

Normal fresh-air mode:
LED's off.

AUC – on: Left LED on. The pollution level is detected by a sensor. If excessive, the fresh-air outlets are automatically closed and the system switches to recirculated air control.

Recirculated air: Right LED on.

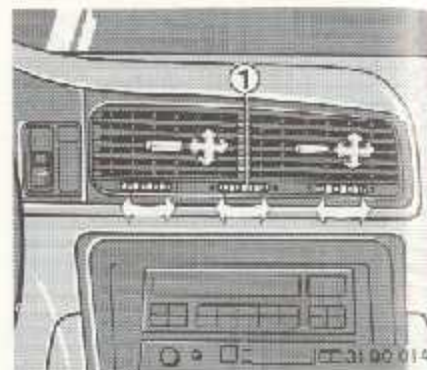

Stratified temperature pattern conducive to fatigue-free driving

Driver's and passenger's side:

Air entering through the outlets at the instrument panel and doors can be varied by turning the thumb wheel (1) (not when air conditioning is operating at maximum).

Turn thumb wheel to the:
right – warmer
left – colder

Important

The air con

When the

at least on

When swit

ally contr

tioned. ca

The air co

at least on

Important

year, to s

seals from

gerant to e

If any mal

noted – fi

lary temp

Important notes:

The air conditioning system operates only when the engine is running.

When the air conditioning is switched on, at least one air outlet must be open, or else the evaporator may ice up.

When switching off the engine, the electrically controlled air inlet flaps are repositioned, causing a slight noise.

The air conditioning should be run briefly at least once a month. This is particularly important during the cold season of the year, to prevent the compressor shaft seals from drying out and allowing refrigerant to escape.

If any malfunction of the air conditioning is noted – for instance air conditioning rotary temperature control on the driver's side is in maximum position for cooling and still no cooled air is supplied – the system should be switched off at once and the car taken without delay to a BMW dealer.

Microfilter

Outside air is drawn through a microfilter. Pollen is filtered out 100%, dust particles up to 60%. Filter changing is part of the BMW Service. A reduced airflow indicates an earlier than normal filter change.

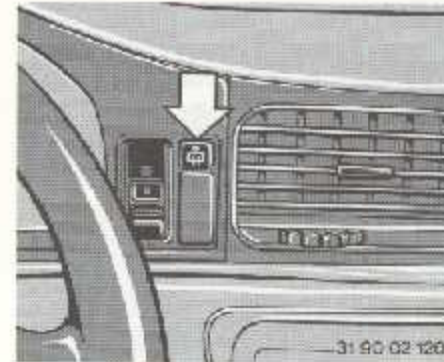
**Rear window defogger**

Push the button: As long as the LED is on, the defogger works at the maximum defrost setting.

When the LED goes out the system operates at an energy-saving level for about 20 minutes.

If further defogging is required: Push button again. The maximum defrost setting will work again.

To switch off: Push button while the LED is lit.

Note:

After every engine start, push button to switch on the defogger.



Operating instructions

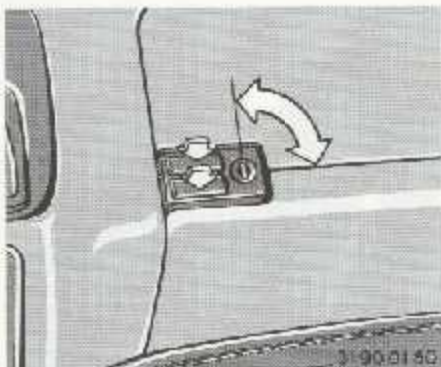

Rechargeable flashlight

When the lower glove box lid is open, the flashlight plug can be reached. The flashlight has a built-in overload device and can thus remain plugged in at all times so that it is fully charged whenever needed.

However, when the battery(-ies) of the car is disconnected, pull the flashlight out of the plug.

Warning:

Do not plug the flashlight in while it is still switched on.

Glove boxes

To open: Press appropriate latch. The glove box lamp lights up.

To close: Push glove box lid into the lock.

To lock: Only possible with the master key. With the glove boxes locked, the trunk is also locked.

Caution:

To reduce the risk of personal injury in an accident or sudden stop, keep glove boxes closed while driving.

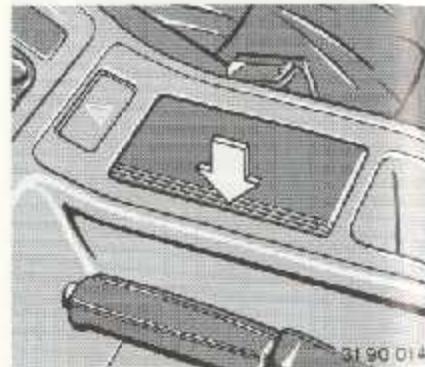

Ashtray

To open: Briefly tap at the left side of the lid (arrow).

To extinguish the cigarette use the funnel in the ashtray.

To clean i
lower as s

Cigarette
Press in t
ment has
knob will
be remov

Lighter s
The sock
accessori
sliver or
more tha
that the
tempting
pattern.

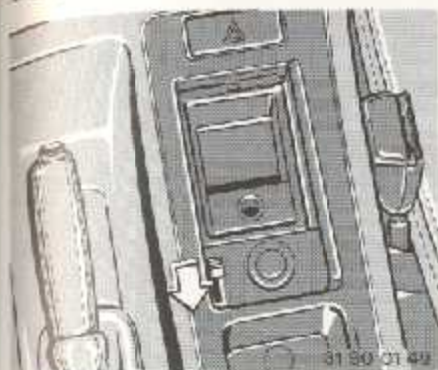

To clean ashtray: With the lid open, push lever as shown and take the ashtray out.

Cigarette lighter

Press in the knob. When the heating element has become sufficiently hot, the knob will pop out and the lighter can then be removed from its socket.

Lighter socket

The socket can also be used to plug in accessories such as a hand lamp, electric shaver or similar appliance rated at not more than 200 Watt, 12 Volt. Make sure that the socket is not damaged by attempting to insert plugs of a wrong pattern.

Warning:

Cigarette lighter and socket remain functional after the ignition key is removed. Therefore, never leave children inside the vehicle unattended. Never touch the heating element or the side of the lighter, hold at the knob only.





...the ...
 ...the ...
 ...the ...
 ...the ...
 ...the ...
 ...the ...
 ...the ...
 ...the ...
 ...the ...

...the ...
 ...the ...
 ...the ...
 ...the ...
 ...the ...
 ...the ...
 ...the ...
 ...the ...
 ...the ...
 ...the ...



...the ...
 ...the ...
 ...the ...
 ...the ...
 ...the ...
 ...the ...
 ...the ...
 ...the ...
 ...the ...
 ...the ...

	Driving hints	70
	Car radio	73
	Engine hood	75
	Engine compartment	77
	Engine oil	78
	Fluid for hydraulic brake booster and power steering	80
	Brake fluid	80
	Coolant	81
	Windshield and headlight washer	83
	Battery(-ies)	84
	Fuses	86
	Towing	87
	Jump starting	88
	Spare tire changing	90
	Manual operations in case of an electrical defect	93
	Changing of wiper blades	94
	Bulb changing	95
	Winter operation	101
	Roof rack	105
	Antilock Brake System (ABS)	106
	Disc brakes	107
	Tires	109

Hints

Driving hints

Engine

Do not allow the engine to reach its normal operating temperature with the car standing still.

Only in very cold weather have the engine run for a half minute with increased idle speed to ensure proper lubrication.

Never run a cold engine at excessive engine speeds, for it would affect the running life.

When driving under high engine loads (steep upgrades, acceleration) the engine speed should be always above 1500 rpm. Shift back as soon as possible, particularly at steep upgrades.

After driving for some time in dense city traffic or bumper to bumper, we recommend letting your engine "take a deep breath" by covering a mile or two at engine speeds of 3,000 rpm. This will help eliminate any carbon build-up in the cylinders.

Your car's fuel economy is mainly dependent on your style of driving. High-speed driving, acceleration to the limit in all gears, violent cornering and sudden braking all take their toll, not only in terms of heavy fuel and oil consumption, but also faster wear of brakes, tires and all the engine parts.

Clutch

When declutching, press the clutch pedal fully down. Do not rest your foot on the clutch pedal.

Caution:

Do not drive with your foot resting on the brake pedal. "Riding" the brakes may result in abnormally high temperatures, lining wear and possible brake failure.

Aquaplaning

When driving on wet or slushy roads, a wedge of water may build up between the tires and the road. This phenomenon is known as aquaplaning and may cause partial or complete loss of traction, vehicle control or stopping ability. Reduce speed on wet roads.

Rear window shelf

Do not put packages on the flat area behind the rear seat, as they may obscure vision and may become dangerous projectiles in the event of a sudden stop.

Clothing hooks

Hang clothes in such a way that they do not impair the driver's vision.

Do not hang heavy objects on the coat hooks. They could cause personal injury in the event of a sudden stop.

Trunk

Always keep the trunk lid closed when on the move. This will prevent toxic exhaust gas from being drawn back into the car's interior. Inhalation of exhaust gas is hazardous to your health. If you are carrying bulky items and cannot close the lid, it is a good precaution to close all the windows, including the sliding roof if equipped, and run the fresh air or heater blower at medium to high speed.

Warning:

Drinking and driving is dangerous. Even a small amount of alcohol or drugs can affect your reflexes, perceptions and judgement. The possibility of a serious or even fatal accident is increased when you drink and drive.

Catalytic converter

The catalytic converter is designed to convert leaded fuel into unleaded fuel.

If leaded fuel is used, the short period of time the catalytic converter is rendered inoperative.

Have the converter replaced to ensure proper functioning.

To fulfil its function, the oxygen sensor must be replaced after 50,000 miles.

After 50,000 miles, the oxygen sensor should be replaced.

Catalytic converter

The catalytic converter of your BMW is designed to remove pollutants of **un-leaded fuel only**.

If leaded fuel is used – even if only for a short period – the **oxygen sensor** and **catalytic converter** will be damaged and rendered inoperative.

Have the scheduled maintenance performed to ensure undisturbed engine functions.

To fulfil EPA Emission Standards the oxygen sensor and catalytic converter must be replaced after using fuel containing lead. The catalytic converter is integrated into the exhaust system.

After 50,000 miles (or 80,000 km) the oxygen sensor must be replaced.

If unburned fuel reaches the catalyst, excessive temperatures and damage may result. You should therefore avoid all operating conditions that are likely to cause unburned or insufficiently burned fuel reaching the catalyst, e.g.:

- Unnecessarily prolonged operation of the starter motor or repeated cranking without the engine starting. (A fully functional engine may be stopped and started without problems)

Tow start only with a cold engine, as otherwise unburned fuel reaches the catalyst – use starting cables

- Allowing the engine to run with spark plug wires disconnected
- Never run out of fuel to avoid mistfiring of engine.

If the ignition should mistfire, please drive to the nearest BMW dealer, using low engine speeds only.

Note:

Do not park or operate the vehicle in an area where the hot exhaust system may come in contact with dry grass, hay, leaves or other material which can cause a fire.

Evaporative Emission Control System

This is a purge system consisting of a liquid vapor separator, charcoal canister and purge lines to prevent gasoline vapors from escaping into the atmosphere.

BMW
Accessories

Hints

Traveling in foreign countries

Prior to using your BMW in a foreign country, check to ascertain if fuel of the required octane level is available to avoid engine damage.

Should unleaded fuel not be available in the foreign country in which you are traveling or intend to travel, be aware that the use of leaded gasoline will render the oxygen sensor and catalytic converter of your BMW inoperative. As a result, the vehicle will not meet the emission requirements of the US and Canada and maximum fuel economy will not be obtained. It will, therefore, be necessary upon your return to the US or Canada for the fuel system to be purged of the leaded fuel and both the oxygen sensor and catalytic converter to be replaced in order for the vehicle to be legally operated in the US and Canada.

Reductions in exhaust emissions, fuel consumption and the quality of the fuel used influence the running characteristics of the engine.

Varying operating conditions are largely compensated by the measuring and control functions of the car's electronic system and by the high production standards of individual components. Individual systems such as electronic ignition and fuel injection are also important in this respect.

Unusual engine and drive characteristics, for example, when accelerating from a low engine speed, when combustion recommences after the overrun fuel shutoff has operated or at a low engine idle speed, are design features resulting from the compromise between demands for lower fuel consumption, ecologically more acceptable motoring and greater ride comfort, and not a sign that the vehicle needs attention.

BMW cannot be responsible for mechanical damage that could result from inadequate fuel, service or parts availability.

[Faint, illegible text from the reverse side of the page.]

Radio

If your
will rec
with th
full det
radio.

The fro
the so
speake

The st
your ca
ity of t
depend
and th
tenna.
take in
ceiver,
cession
of the r
it is i
aligned
mission

Climat
Fog, ra
radio n

Radio operation

If your BMW is equipped with a radio, you will receive an owner's instruction manual with the car's documents; this contains full details of **how to operate your car radio**.

The front-to-rear fader control distributes the sound between the front and rear speakers.

The strength of the signal received by your car radio antenna, and thus the quality of the sound from the loudspeakers, depend on the position of the receiver and the height and direction of the antenna. These factors are relatively easy to take into account on a home radio receiver, but for a mobile radio certain concessions have to be made. The position of the receiver is constantly changing and it is impossible to keep the antenna aligned with the direction of signal transmission.

Climatic effects:

Fog, rain or snow can interfere with good radio reception.

As the **strength of sunlight** increases, long, medium and short wave reception is adversely affected. These wavebands can be best heard after dark, when the ionosphere reflects more of the transmitted signal back to earth.

AM provides a larger or, in some cases, exceptionally wide reception range, since the signals are not only dispersed as **ground waves**, which cling to the curvature of the earth, but also as **space waves**, which are reflected off a layer in the ionosphere and bounce back to earth.

There are physical reasons why the quality of AM reception is not as good as on FM. However, long distance reception is good, particularly at night, so that a large number of stations can be received, though the station density is such that mutual interference often occurs.

The **FM** transmission system offers far better sound quality than AM. However reception is limited to only a few stations at a time, since the radio waves are emitted in a **straight line** from the transmitter tower and thus cover an area not more than about 50 miles (80 km) in radius.

As the distance from the transmitter to the receiver increases, background noise becomes more of a problem, and finally the station can no longer be heard and is displaced by a more powerful one which the car is approaching. These too, are natural factors which can only be avoided by retuning to a stronger signal.

Stereo, if transmitted in your area, can only be received on FM. As you move away from the transmitter, interference becomes noticeable more rapidly than on mono transmissions. In this case, switch to mono reception or tune to another station giving reliable stereo reception.

Hints

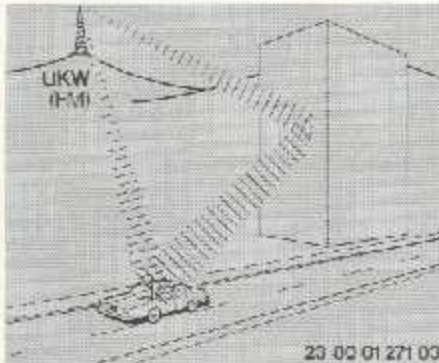

Fluttering noise is caused by signal fade, when the line-of-sight link between transmitter and receiver is blocked by large buildings or geographical features. A similar effect is sometimes heard when driving along a treelined road.

Hissing, sizzling and splashing noises: disturbance in this category occurs when reflected signals are picked up by the car radio a fraction of a second after the main signal, for instance from large buildings nearby. The sound level also fluctuates repeatedly.

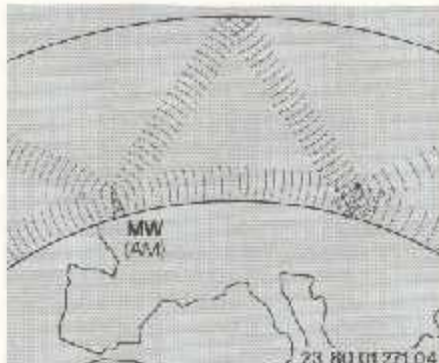

Continuous high level of background noise: this normally indicates that the edge of the transmitter's zone has been reached, or the car has been driven into a "shadow" where no direct signals are received. The only alternative is to return to a more powerful station.

Severe fade: this is a phenomenon more often encountered on AM, and accompanied by distortion. It is caused by the superimposing of ground waves and air-borne signals at the reception point.

Telephone

In order to take maximum advantage of the many features of your telephone, refer to the separate Owner's Manual. Servicing can be performed by your BMW dealer.

Note:

Mobile communication systems, particularly if not properly designed for automotive use or not properly installed, may adversely affect the operation of the vehicle, for example, such systems, when operated, may cause the engine to stumble or stall. In addition, such systems may themselves be damaged, or their operation affected, by the operation of the vehicle.

Do not operate systems with the antenna inside of the vehicle.

Because BMW has no control over the design or manufacture of such systems, or their installation, BMW cannot assume responsibility for any such adverse effects or damage.



Hood

The hood is pulled out of the front of the car.

Warning: Before you open the hood, make sure the engine is cool. Do not touch the fan blades. When the hood is open, do not touch the repair area in the engine compartment.

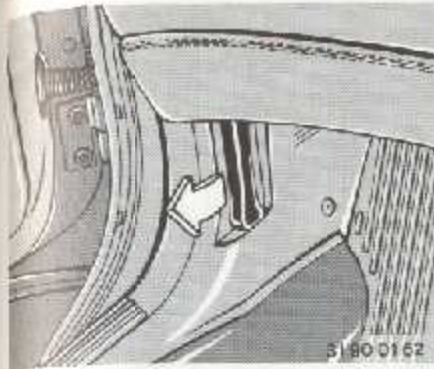

3190 01 62

Hood

The hood is unlocked from inside the car by pulling the lever on the left side panel of the footwell.

Warning:

Before you check anything in the engine compartment, stop the engine and let it cool down. Hot components can burn skin on contact. Never touch the radiator fan blades.

When there is danger of coming in contact with electrical cables, when doing repair and maintenance work, especially in the engine compartment, always disconnect the battery.

Improper handling of parts installed and materials used in the vehicle can endanger your personal safety. Always pay attention to manuals and instructions. If you are not familiar with the pertinent safety rules, ask your BMW dealer to perform the necessary work.

Several parts of the car's equipment are made of asbestos. Asbestos fibers may be present in the form of dust and could cause cancer and lung disease. Please note warnings marked on the spare parts.

Any contact with ignition components when the engine is running is highly dangerous.

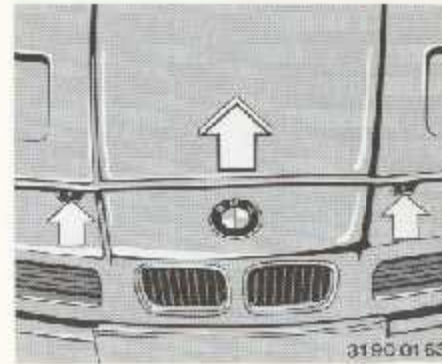

3190 01 63

To open: Push both levers in the direction as shown and lift the hood.

Engine compartment light

The light goes on with the hood open and the parking light switched on.

Hints

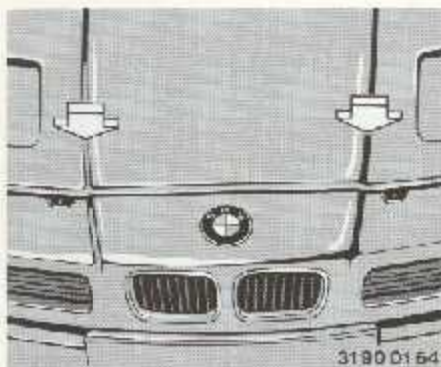

To close: Lower the hood down and press it into the locks with an audible click.

Caution:

To avoid injury when closing the hood, do not place your hands into the cut-outs for the headlights.

Should you notice at any time while driving that the hood is not secured properly, please stop at once and close it.

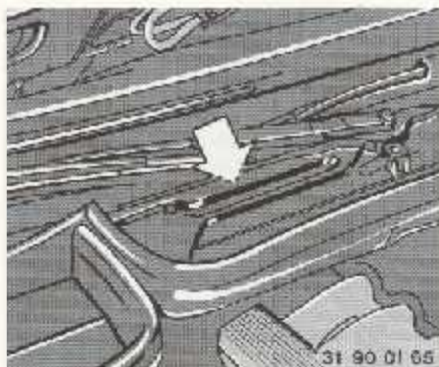

Chassis number

The chassis number can be used to check the identity of your car against your registration and licensing certificates.

The chassis number is in the engine compartment beside the right wiper arm (arrow) and on a label located inside the left front door opening.

The number is also stamped on a metal strip that is fastened to the dash adjacent to the middle of the windshield.

Engine

- 1 Fuse b
- 2 Tank f
- 3 Fluid t
boost
- 4 Engine
- 5 Coola

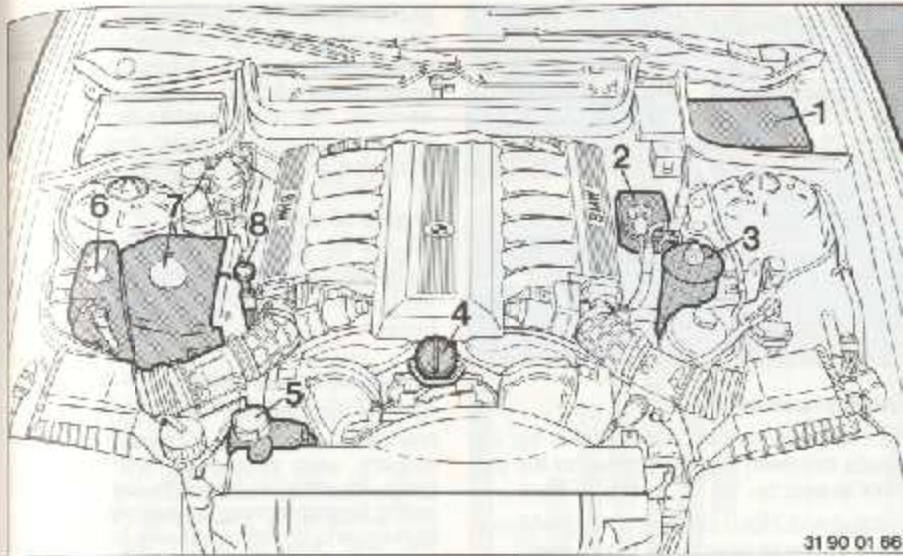

31 90 01 86

Engine compartment

- 1 Fuse box
- 2 Tank for brake fluid
- 3 Fluid tank for power steering and brake booster system
- 4 Engine oil filler
- 5 Coolant tank
- 6 Fluid tank for intensive cleanser
- 7 Fluid tank for windshield washer (The fluid tank for headlight and fog light washer's is in the trunk).
- 8 Dipstick for engine oil.

Hints

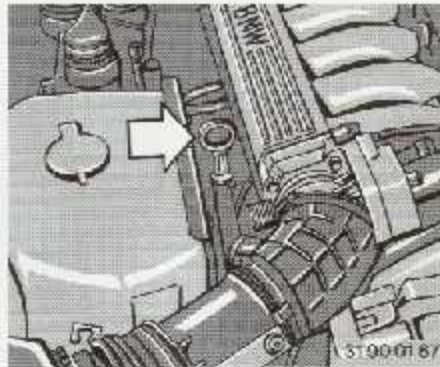

Engine oil

Engine oil level check

We recommend that you check engine oil level regularly, for instance whenever you buy fuel. If necessary, add fresh oil to the filler on the engine's rocker cover. Do not fill beyond the upper mark on the dipstick.

The most accurate oil level reading will be obtained with the car standing on a level surface and the oil cold (before the engine is started); or if the engine has already been run, allow the oil to drain back into the oil pan for a short period.

Make sure that the dipstick is inserted fully into the tube on the engine block.

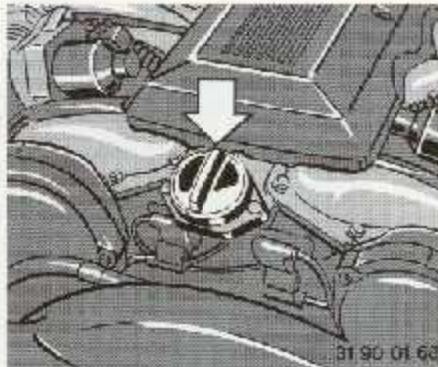

Adding fresh engine oil

The quantity of oil represented by the space between the two marks on the dipstick is approx. 1.1 US quarts (1 liter).

Adding too much oil serves no useful purpose and may even harm the engine.

Since this excess oil will tend to be burned off within a short time, it may create the impression that oil consumption is higher than normal. The best procedure is to add fresh oil only when the level has dropped almost to the lower mark on the dipstick. However, do not allow the level to fall below the minimum-level mark.

BMW engines are designed to require no oil additives if one of today's highly advanced brand-name lubricating oils is used. Using additives could cause engine damage. The same applies to the oil for the manual or automatic transmission, final drive and power steering.

Engine oil consumption

Engine oil consumption, like fuel consumption, depends on the way in which the car is driven and the operating conditions.

Engine oil specifications

API SF/SG grades are highly recommended due to their increased oxidation stability, wear protection, and detergent properties. The increased level of protection available by the use of SF grade oil will help you to attain the maximum amount of engine service engineered into your BMW.

Combinat
OC/CD/C

The chart
used dep
temperat

The temp
may rem

a short p
Heavy du
manual t
extremel
BMW de

Note:
Under
strongly
oil servic

Caution
For dis
local re
We sug
your BM
Continc
has cau
Wash
water a
Always
reach
tions o

require highly...
g oils...
se engine...
he oil for...
mission...

fuel con...
in whic...
ng cond...

y recom...
oxidation...
detergen...
of protec...
grade o...
maximum...
bered into

Combination with Diesel oil specifications CC/CD/CE are also permitted.

The chart indicates the SAE grades to be used depending on the predominant air temperature.

The temperature set by the SAE grades may remain under or exceed the limit for a short period.

Heavy duty engine oil may be used in the manual transmission if the car is driven in extremely cold climates. Contact your BMW dealer for details.

Note:
Under severe driving conditions, we strongly advise increasing the number of oil services.

Caution:
For disposal of used engine oil obey local regulations or environmental rules. We suggest you have the oil changed at your BMW dealer.

Continuous contact with used engine oil has caused cancer in laboratory tests. Wash skin thoroughly with soap and water after handling. Always keep oils, greases etc. out of reach of children! Please note precautions on containers.

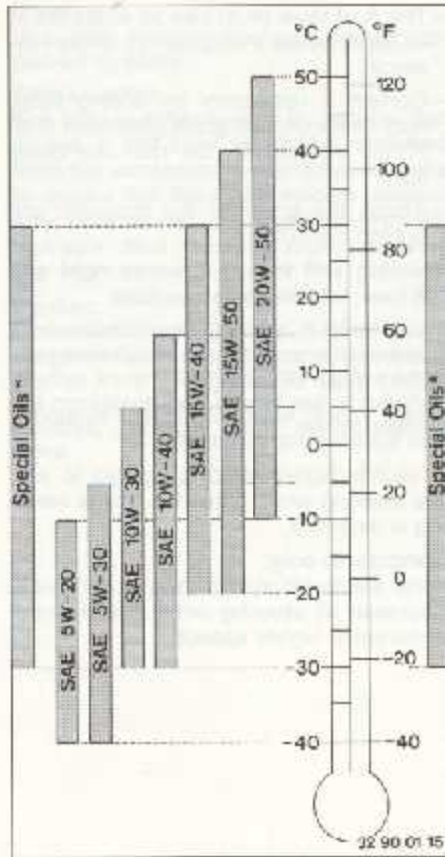

* Special engine oils individually approved by BMW (low-friction lubricants). Contact your BMW dealer for details.

Hints

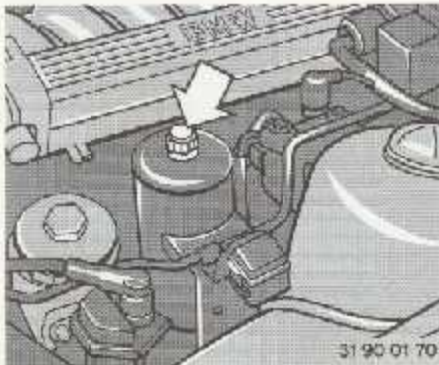

Fluid for hydraulic brake booster and power steering

Fluid level check

- Check fluid level in the power steering with the engine stopped, remove the nut and take off the fluid reservoir cover.
- Apply the foot brake several times until the fluid level stops rising or the pedal becomes difficult to press down. About 10 brake applications will be necessary.

- The fluid level must rise to about 0.8 in (20 mm) below the upper rim of the reservoir.
- Correct if necessary by adding more fluid of the proper grade (Pentosin CHF 7.1 or equivalent). Do not use brake fluid.
- Attach the cover to the reservoir and tighten the nut.

Steering stiff to turn towards right and left lock; whining noise audible:

Too little oil in system. Check level and if necessary inspect the power steering circuit for leaks or damage.

Loose V-belt: Adjust to correct tension. If belt is damaged, replace it.

A slightly higher effort is needed to turn the steering wheel when the power steering is defective.

Servotronic only:

If the electronic system fails, a noticeable decrease in steering effort will become apparent at higher speeds.

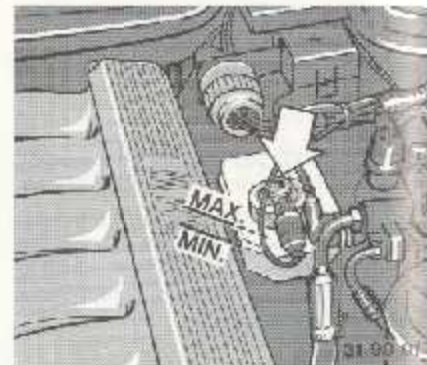

Brake fluid

Top up to the "MAX" mark.

Use only DOT 4 brake fluid.

Brake system

If the warning light for brake booster and power steering hydraulics goes on and the MID display (LOW BRAKE FLUID) signals a fault, there might be a loss of brake fluid, followed by increased brake pedal travel.

Failure of one brake circuit

Pedal travel will increase and greater pedal effort will be needed.

The car can still be braked satisfactorily with only one circuit in operation.

As for all brake system faults, the car should be taken to a BMW service station for immediate repair.

A flashing warning light and the MID display ASSIST INTACT indicates:

- with increased brake pedal pressure: Loss of pressure in the booster system, no brake assistance
- with steering wheel stiff to turn: System pressure lost, no power steering servo
- with increased brake pedal pressure and stiff steering: Servo pump inoperative or drive belt defective.

MID display BRAKE LININGS:

Brake pads worn. Have pads renewed without delay.

Warning:

Use only brake pads and linings approved by BMW.

Brake system

The fluid is hygroscopic by nature, that means it will tend to absorb moisture from the atmosphere over time. In order to ensure that the brake system remains fully operational, the brake and clutch hydraulic fluid must be replaced every two years.

Caution:

Brake fluid is poisonous. Brake fluid is also harmful to the paint of your vehicle. Always keep it in the tightly sealed original container, and stored out of reach of children. Comply with environmental rules.

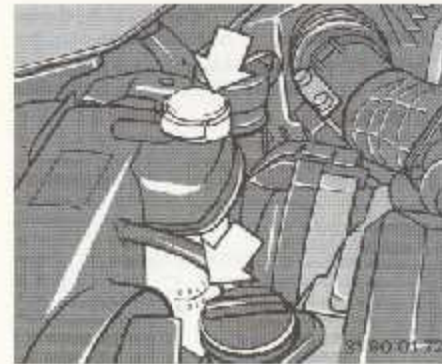

Coolant level check

The transparent coolant tank permits coolant level to be checked without removing the cap. The cooling system holds approx. 12.7 US quarts (12 liters).

Warning:

Open the radiator cap only when the engine has cooled down and the coolant needle is on the lower third of the scale, otherwise hot water or steam may escape and scald you.

An overheated engine may cause fluids (e.g. brake fluid, antifreeze, gasoline) which have leaked into the engine compartment to ignite!

Turn the cap slightly counterclockwise to allow excess pressure to escape, then remove completely.

Hints

Overfilling will dilute the additives in the coolant, which will escape through the overflow pipe and no longer possess the correct antifreeze and corrosion inhibitor concentration.

Never add water if the cooling system is still hot and coolant has been lost; allow the engine to cool down.

Apart from regular checks on coolant level, antifreeze concentration [at least 50% = -35°F (-37°C) year round] and the condition of hoses and hose clamps, we recommend that the cooling system be **drained and refilled every two years**. At the same time, check that the filler cap seals properly and that the pressure relief and vacuum equalizing valves (both located in the radiator cap) are in good working condition.

The fluid of the cooling system needs no further additives. Use only reputable brand ethylene glycol antifreeze with corrosion inhibitors that are nitrite- and amino-free and compatible with aluminum radiators.

Increasing the antifreeze concentration in the coolant is not only uneconomical, it is also detrimental to engine cooling.

Antifreeze other than specified by BMW for aluminum radiators may cause corrosion of the cooling system, leading to engine overheating and damage.

Caution:

Antifreeze is poisonous. Store in original fluid container only, and always keep out of reach of children.



Wind Inters

The fi
quarts
Top u
able i
tectio
Wind!
The fi
quart
In co
syste
addin
prop
factu
Wind
If a
juste
repor
the v

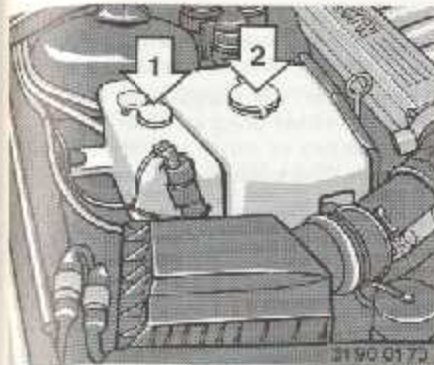

Windshield and headlight washer Intensive cleanser (1):

The fluid tank holds approximately 1.1 US quarts (1 liter).

Top up with Intensive cleaning fluid available at your BMW dealer. Freezing protection is down to -17°F (-27°C).

Windshield washer (2):

The fluid tank holds approximately 2.8 US quarts (2.5 liter).

In cold weather, the windshield washer system can be kept fully operational by adding windshield washer solvent in the proportions recommended by the manufacturer.

Windshield washer jets:

If a stream of water is improperly adjusted/aimed, the jet can be carefully repositioned with a fine needle to redirect the water stream.

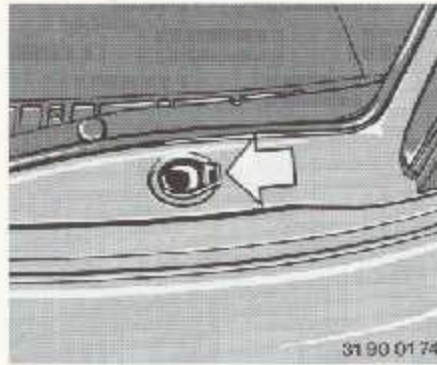

Headlight fog light washer

The fluid tank and the filler nozzle is in the trunk.

The fluid tank holds approximately 9.5 US quarts (9 liter).

In cold weather, the headlight washer system can be kept fully operational by adding windshield washer solvent in the proportions recommended by the manufacturer.

Note:

Do not run the headlight washer if the fluid tank is empty.

Washer jets for headlights and fog lights:

Have them adjusted by a BMW dealer, if necessary.

Hints

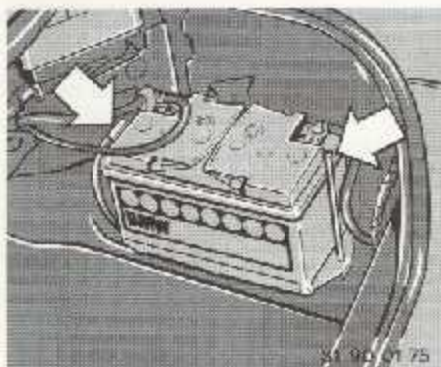

Battery

The battery* is behind the side lining in the trunk. A positive terminal for jump starting is in the engine compartment, see page 88.

Your BMW's battery is maintenance free. The electrolyte added initially should normally last for the life of the battery. **If the level is too low in any of the cells, for instance after spending long periods in a hot climate, top up with distilled water (do not use acid).**

The level should be about 0.2 in. (5 mm) above the upper edges of the plates or at the mark visible in the filler opening, depending on battery type.

Keep the upper part of the battery clean and dry.

* Some vehicles may contain a second battery on the right side.

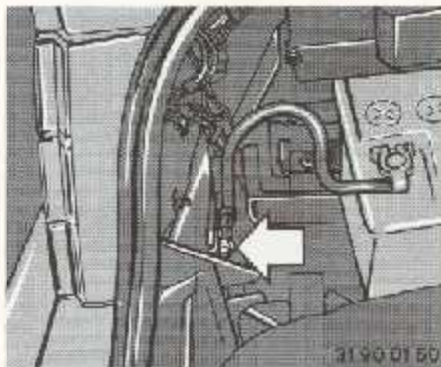

Caution:

If your vehicle is equipped with two batteries, never disconnect only one battery. Always take off either the negative terminals or the negative connection of both batteries (arrow), see picture.

If you are not familiar with carrying out the necessary work, contact your BMW dealer.

Important notes:

1. Acid or lead oxide from the battery terminals must never be allowed to contact the eyes, skin or clothing. Rinse off immediately with clean water, and consult a physician if necessary.

2. Never short-circuit the battery posts; this will cause severe overheating and could lead to the battery case bursting.

3. When the cell plugs have been removed, never bring an open flame near the battery or cause any sparks in the vicinity. This could lead to an explosion.

4. Never detach the battery leads when the engine is running; otherwise an overvoltage will occur and damage the car's electronic equipment beyond repair.

First disconnect the negative leads, then the positive leads and remove the evaporative system. Unscrew the battery retaining bar. When installing, tighten the original BMW battery with the retaining bar and connect first the positive lead, then the negative leads. Check tightness of plugs and the evaporative system.

Avoid crimping or blocking the vent tube when reinstalling.

5. To reach it first stopper cable connector. Never explode. All first.

6. Disconnect battery the car risk of

y post-
ring and
bursting.
been re-
me near
ks in the
xplosion.
ds when
wise at
nage the
yond re-

e leads
rove the
the bat-
nstalling
ery with
first the
ve leads
he evap-

the vent

- 6 To recharge the battery without removing it from the car, the engine must be stopped. Connect the positive (+) cable of the charging appliance to the remote positive (+) post in the engine compartment.
Never charge a frozen battery. It may explode because of gas trapped in the ice. Allow a frozen battery to thaw out first.
- 8 Disconnect the negative lead from the battery before attempting any work on the car's electrical system, to avoid the risk of a short circuit.

- 7. If the vehicle is to be laid up and out of use for a fairly long period – see page 123 – remove the battery, have it charged and stored in a cool place with no risk of freezing. The battery must be recharged after not more than 3 months or it will discharge completely and then cannot be reused on the vehicle.
- 8. If one battery is defective, always replace both batteries of the same make.



Hints

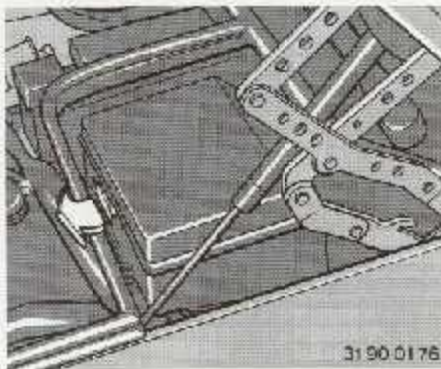

Fuses

If any electrical equipment on your car should fail, switch off the circuit and check the fuse.

The fuse box with spare fuses, fuse removal tool and relays is located on the left wheel arch inside the engine compartment.

- Press latch and remove lid upward.
- Pull the fuse of the defective circuit out with the removal tool.

- Change blown fuse (melted metal strip) and insert a new fuse of the correct rating.

Further fuses are behind the side linings in the trunk. A label with the correct rating and output load circuits is inside each fuse box lid.

If fuse-blowing recurs, contact your BMW dealer to perform the necessary work.

Caution:

Never replace blown fuses with wire or attempt to repair them in any way (fire hazard).

Tool kit

The tool kit is in a rack under the trunk lid which swings down when the retaining screw is loosened.

Freeing sand

If your car is stored in a garage, sand can get into the front or rear wheel arches.

Note: Screw

Freeing vehicle from mud, sand or snow

If your vehicle gets stuck a towing eye is stored in the tool kit. If necessary screw it into the provided threaded bushing in the front or rear of the vehicle.

Note:

Screw the towing eye in firmly until tight.

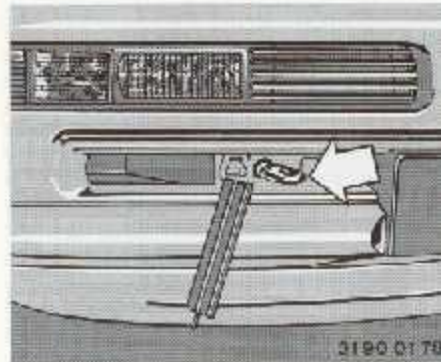

31 90 01 79

Attachment at the front:

Pull off the small front side grill.

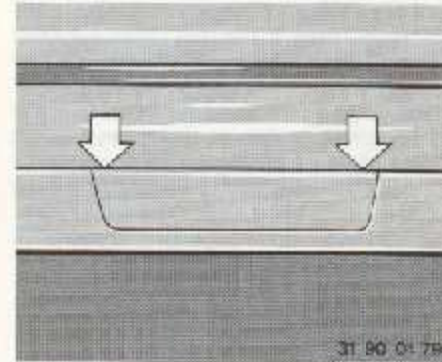

31 90 01 79

Attachment at the rear:

Pry off the cover with a screwdriver (arrows).

When reinstalling, first hook in the lower part of the cover, then press in the top.



Hints

Use only nylon tow ropes or straps sufficiently resilient to protect both vehicles against sudden jerking. Do not tow a car to start it. When the engine starts, the forward surge could cause a collision. Also, under some conditions, the catalytic converter could be damaged. Do not attempt to push another vehicle with yours or allow yours to be pushed by another vehicle. Damage to the energy-absorbing bumpers may occur.

Towing vehicle equipped with automatic transmission

If the vehicle has to be towed with the rear wheels on the ground, towing speed should not exceed 30 mph (50 km/h) and the towing distance should be limited to 25–30 miles (40–50 km). To tow an automatic transmission car more than 30 miles (50 km) add 1.05 US quarts (1 liter) of ATF (automatic transmission fluid) to the contents of the transmission, or remove the drive shaft. After the car has been repaired, do not forget to reduce the fluid level in the transmission to normal.



Towing with a commercial tow truck

Do not tow with sling-type equipment.

Use wheel lift or flat bed equipment.

Please comply with applicable state towing laws.

Warning:

Never allow passengers to ride in a towed vehicle for any reason.

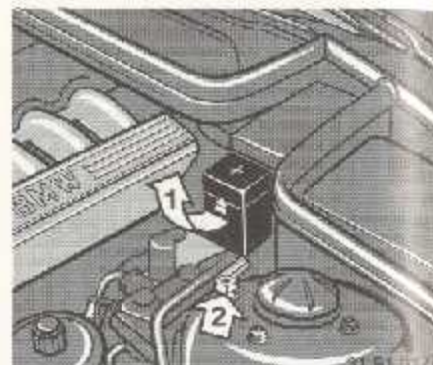

Jump starting

To prevent damage to the air mass meters of the digital engine electronics, do not use starting sprays to start the engine.

If the battery is run down, the engine can still be started by running jumper cables to the battery from a second vehicle.

1. Check that the other vehicle has a 12-Volt electrical system and a battery of approximately the same capacity (Ah).
2. The dead battery has to remain connected.

3. Do not allow the two vehicles to touch each other, or a short circuit may result.
4. First connect the positive terminals of the car's batteries together. The positive terminal of the jumper cable can be connected in the engine compartment on the left side of the heater bulkhead. To remove the cover, pull at the latch (arrow 1). Then connect the second jumper cable to the negative post of the second car's battery and to the negative terminal on the left wheel housing (arrow 2).
5. Run the other car's engine at a steady 2,000 rpm and then start your engine in the usual manner. Before disconnecting the jumper cables make certain that the engine is at idle speed, switch on headlights, blower and rear window defogger to avoid damage to the car's electrical system. Carefully disconnect the jumper cables, starting with the negative terminal.

Warning:

The use of booster batteries with more than 12 Volts may cause immediate and irreparable damage to the electronic components of your vehicle. The capacity (Ah) of the booster battery should not be lower than that of the discharged battery. Use of batteries of different voltage or substantially different Ah rating may cause an explosion and personal injury.

If connections deviate from that described in the foregoing, damage to both charging systems or even serious personal injury could result.

When there is the danger of coming in contact with cables, for instance while doing repair and maintenance work, especially in the engine compartment, always disconnect the battery.

Improper handling of parts installed and materials used in the vehicle can endanger your personal safety. If you are not familiar with the pertinent safety rules, ask your BMW dealer to perform the necessary work.

The ignition system is a high-performance system and any contact with live components when the engine is running could lead to a fatal electric shock.

When attempting any repair or checking procedure, make sure that there is no loose or hanging clothing and avoid contacting rotating fans and belts.

Hints

Spare tire changing

Flat tires are fortunately a rare event nowadays. However, should you have the misfortune to suffer a puncture, drive the car away from the main traffic stream and apply the parking brake. Comply with local regulations concerning the hazard of immobile vehicles by switching on the hazard warning flashers and setting up a warning triangle, flashing signal lamp etc. at a sufficient distance away from the car.

Apply the parking brake and select 1st gear or reverse gear, or on automatic transmission cars, put selector lever into position P.

To prevent noise when the jack is stored in the trunk again, fit and secure it in the original position.

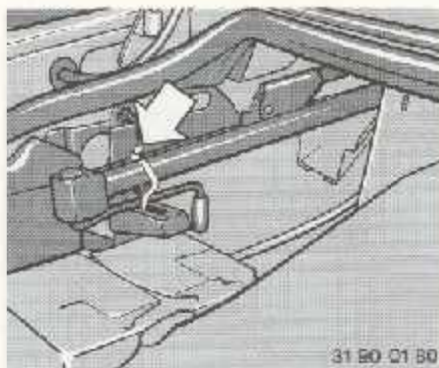

For changing tires, you need:

Jack

The jack is housed in the trunk behind the left side lining. To remove the lining, pull it by its recessed handle. Release the spring clamp (arrow) and take out the jack.

After using the jack, lower its lift arm fully and put the bottom of the jack into the support, pushing the jack to the front to secure it.

Wheel chock

The wheel chock is placed below the jack. On flat, even surfaces, put the wheel chock behind the opposite rear wheel to prevent the car from moving when it is raised on the jack (this is necessary due to the parking brake design). On inclined surfaces, additionally secure the vehicle from rolling away.

Wheel bolt wrench

The wrench is in the tool kit under the trunk lid.

Spare tire and hexagon socket

Both are housed in the trunk below the carpet. Take out the carpet, the hexagon socket and, after unscrewing the wing nut, the spare tire.

Note the turbo styling on the light alloy wheels. These wheels are asymmetrical and therefore dependent on the driving direction. The spare tire corresponds to the right side of the vehicle.

In an emergency, it can be fitted to the left side too. Return the correct wheel to the correct side as soon as possible.

Procedu

1. Take c
- Put th
- and t
- catch)
2. Loose

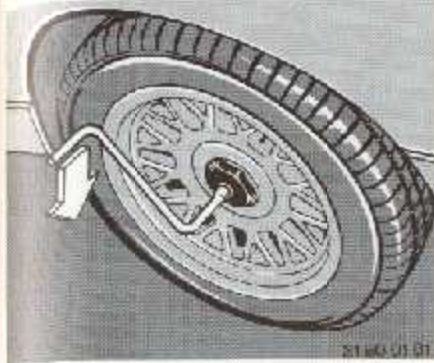

31 90 01 01

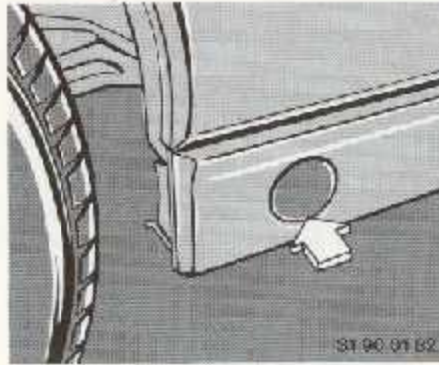

31 90 01 02

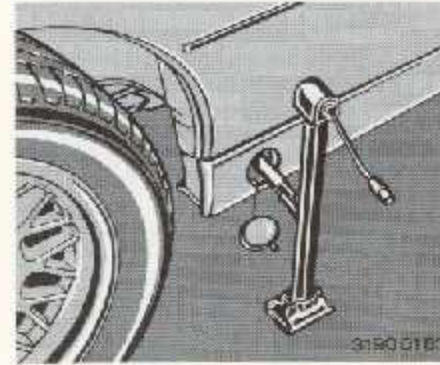

31 90 01 03

Procedure

1. Take off the wheel bolt cover. Put the hexagon socket on the cover and turn counterclockwise (bayonet catch).
2. Loosen wheel bolts a half turn.

3. Take off the appropriate cover for the jack attachment by pushing it in at the bottom (arrow).
4. Fit jack fully into the attachment and make sure the jack bottom stands firmly on the ground.

5. Lift the vehicle until the appropriate wheel is clear of the ground.

Warning:

Never work underneath a jacked-up vehicle. Use the jack only for changing a spare tire. Never use the jack to lift other vehicles or other loads as this may lead to accidents and personal injury.

8. Unscrew wheel bolts and take off wheel.



Hints

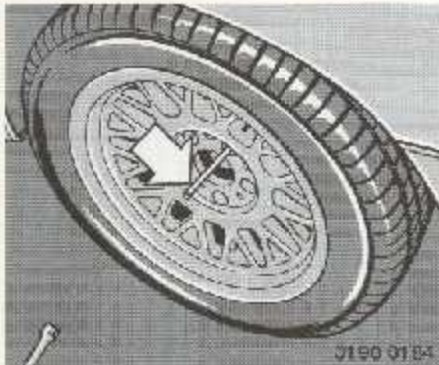

7. Fit the centering pin (found in the tool kit) with the plastic guide into one threaded hole.
8. Put the spare tire on to the centering pin and screw in two bolts. Take out the centering pin.
9. Screw in the remaining wheel bolts and tighten them uniformly.
10. Lower the vehicle, take off the jack and fit the cover for the jack attachment by inserting it at the bottom and press in at the top.

11. Tighten all wheel bolts finally in a crosswise pattern.

Note:

Have the tightening torques checked at the earliest opportunity [81 lb-ft (110 Nm) with a calibrated torque wrench].

If a new tire (or the spare tire) is installed for the first time, have tightening torques of bolts checked after approx. 600 miles (1,000 km).

Have the flat tire repaired and rebalanced as soon as possible.

12. Fit the wheel bolt cover by hand. The valve symbol should point to the tire valve.

Make sure not to damage the mounting bolt in the trunk when storing the wheel.

When fitting other than original BMW alloy wheels, make sure to use the correct wheel bolts.

Have the flat tire repaired and rebalanced as soon as possible.

Tire repairs should always be entrusted to a BMW dealer or a specialist tire dealer capable of examining the tire to determine the full extent of possibly concealed damage.

Caution:

When removing or replacing tubeless tires, the rubber valve must also be replaced as a safety precaution.



Manual operations in case of an electrical defect

Unlocking the fuel filler flap

Take latch (arrow) out of the side lining and pull rearward.

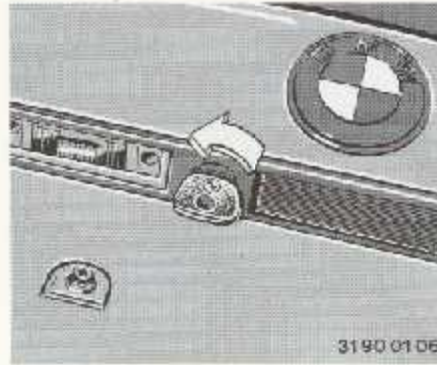

Trunk lid

- Insert **master key** into the lock next to the latch.
- Turn key and pull it out in the insert position.
- Press in the lock.

The trunk is locked again when the trunk lid is pushed down and closed.

Note:

If the theft deterrent system was activated, the alarm comes on when the trunk is opened manually.

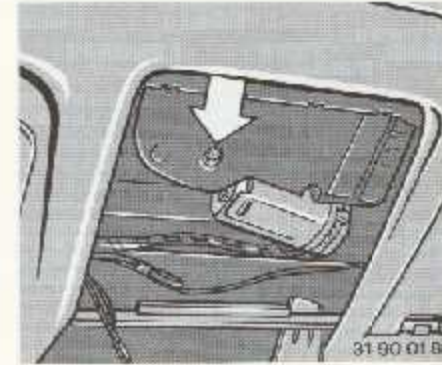

Sunroof

- With the help of a screwdriver remove the interior light.
- Take off the cover.
- Open or close the sunroof by inserting the hexagon key, found in the tool kit, into the hexagon bushing (arrow).

Consult a BMW dealer.

To calibrate the proper function, it may be necessary to synchronize the system:

- Press and hold the switch for 12 seconds (do not tamper with this function).

Hints

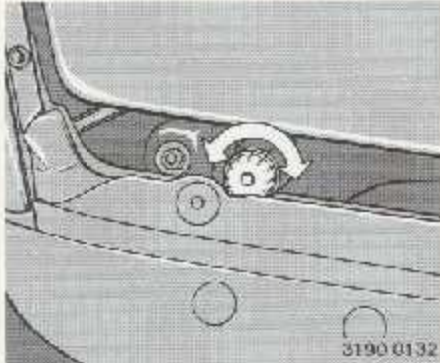

Retractable headlights

- Open the engine compartment
- Turn the knurled wheel either to the left or right until the headlight is fully retracted.

Consult a BMW dealer.

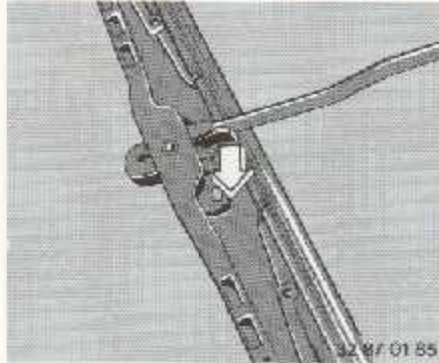

Changing wiper blades

- To position wiper arm (to be lifted) away from the windshield:
Switch on the ignition.
Switch wiper to intermittent function (1).
Switch off ignition when the wipers are in standstill position - they automatically will go to the vertical position.
- Lift wiper arm from the windshield and hold it there.

- To take off the blade on the driver's side, pull (arrow) first the outer and then the inner retaining spring. The wiper for the passenger's side has only one retaining spring.
- Pull off the blade towards the wiper arm.

Bulb ch

When ch
other mir
avoid sho
being rep
necting t

If you ar
safety ru
form the

When re
cloth to l
tion,

Caution:
The hal
pressur
the glas
bulb is c

As corr
particula
safety, t
by a we
ment.

Bulb changing

When changing bulbs or performing any other minor jobs on the electrical system, avoid short circuits by leaving the system being repaired switched off or by disconnecting the negative lead at the battery.

If you are not familiar with the pertinent safety rules, ask your BMW dealer to perform the necessary work.

When replacing bulbs always use a clean cloth to keep the glass free of contamination.

Caution:

The halogen headlight bulb contains pressurized gas. The bulb may shatter if the glass envelope is scratched or the bulb is dropped.

As correct headlight adjustment is of particular importance in view of traffic safety, the headlights should be adjusted by a workshop using the proper equipment.

Retractable headlights

Outer side: Low beam

Center: Fog light

Inner side: High beam

Each is an H1, 55 Watt bulb.

- Take off painted upper part of the retractable headlight by turning the quick fastener.
- Push forward and take it off.

Note:

When refitting the painted upper part assure safe and tight seating.

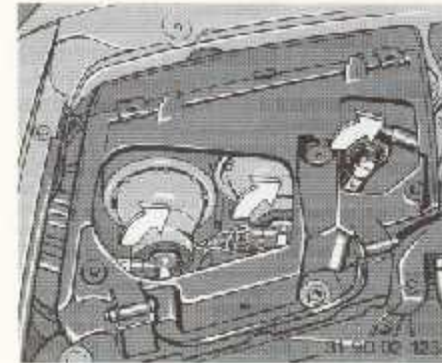

Low beam headlight

The headlight halogen bulbs for the low beams are at the outer side.

Open the engine hood and take off the plastic cover.

Turn the lamp holder with the cable counterclockwise and remove it from the back side of the headlight.

Replace the bulb.

Hints

High beam headlight

The headlight halogen bulbs for the high beams are the inner side.

Open the engine hood and take off the painted upper part.

Turn the lamp holder with the cable counterclockwise and remove it from the back side of the headlight.

Replace the bulb.

Fog light

The bulbs for the fog lights are in the center.

Open the engine hood and take off the painted upper part.

Turn the lamp holder with the cable counterclockwise and remove it from the back of the light.

Replace the bulb.

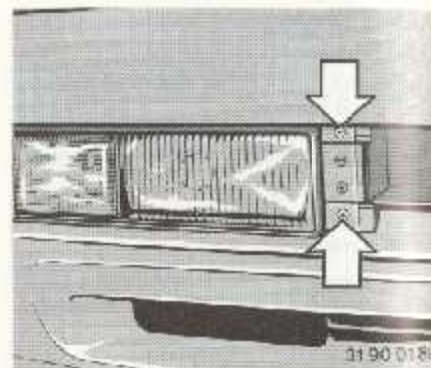

Light cluster

Inner side: High beam/headlight flasher, H 1, 55 Watt bulb.

Center: Park light/daytime running light, 21/5 Watt bulb.

Outer side: Turn signal/side marker, 21 Watt bulb.

To take off light cluster:

- Pull out the small grille.
- Take off both screws (arrows).
- Pull the light cluster to the outer side and take it out of the guide pins.

High beam

- Pry out screws

- Disconnect

- Turn the

- Push counter

- Push counter

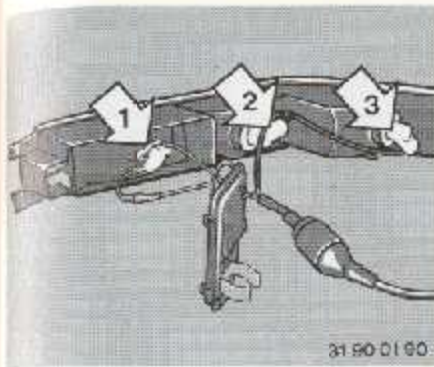
**High beam/headlight flasher (1)**

- Pry out the cover with the help of a screwdriver.
- Disconnect the retaining spring and take out the bulb.

Park light/daytime running light (2)

- Turn the bulb socket counterclockwise and take it off.
- Push the bulb inward lightly, turn it counterclockwise and take it off.

Turn signal/side marker (3)

- Push the bulb socket inward, turn it clockwise and take it off.
- Take off the bulb the same way.

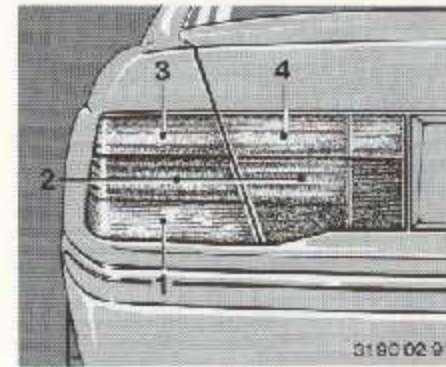
**Rear light**

- 1 Brake (stop) light
- 2 Rear (tail) light/side marker
- 3 Turn indicator
- 4 Reversing (back-up) light

Rear (tail) light: 2 bulbs, each 5 Watt.
All other bulbs: 21 Watt.

Hints



Lights in the side part of the fender:

- Take off side lining using the recessed handle.
- Take off the appropriate bulb holder by pressing it in and turning it counterclockwise.
- Take the bulb out of the holder in the same way.



Light in the trunk lid:

- Take out the quick fastener and lift up the trunk lining.
- Take off the appropriate bulb holder by pressing it in and turning it counterclockwise.
- Take the bulb out of the holder in the same way.

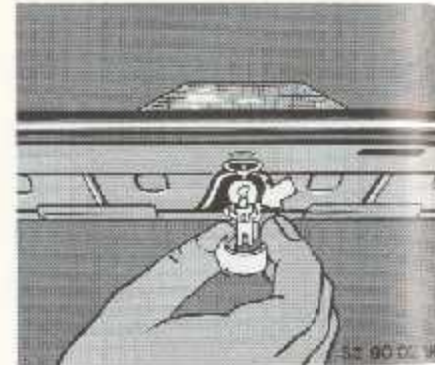

High-mount brake (stop) light

Bulb 21 Watt

- Open the trunk.
- Push the bulb holder inward lightly, turn it counterclockwise and take it out.
- Take the bulb out of the holder in the same way.

License

Bulb 5 W

- Take o
- Remo
- ber se
- Remo
- fact.

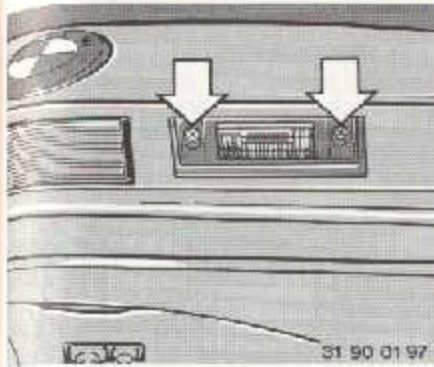
**License plate light**

Bulb 5 Watt

- Take off the screws (arrows).
- Remove the lens frame along with rubber seal.
- Remove the bulb from the spring contact.

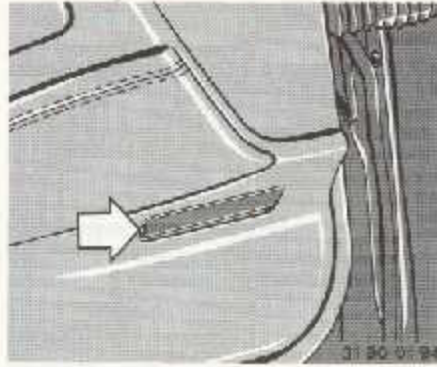
**Footwell lights**

Bulb 5 Watt

- Pry off the lens with a screwdriver (arrow).
- Remove the bulb from the spring contact.

Interior lights**Front:**

Interior and map-reading lights 10 Watt.

- Pry off the lamp from the left side with the help of a screwdriver.
- To take off the bulb of the interior light, push latch of the reflector, push reflector to the side and take off the bulb.
- To take off the bulbs of the map-reading lights, push bulb inward lightly, turn counterclockwise and take off the bulb.

Rear:

Bulb 10 Watt

- Pry off the lamp from the side with the help of a screwdriver.
- Turn reflector to the side and remove bulb.

Hints

Trunk lights

Bulb 10 Watt

Light below the rear shelf:

- Pry off the lamp with the help of a screwdriver.

- Change the bulb.

Light in the trunk lid:

- Pull off the lens.

- Change the bulb.

Glove box light

Bulb 5 Watt

- From the lower glove box, pry off the lamp with the help of a screwdriver at the outer sides.

- Change the bulb.

Faint, illegible text in the left column, likely bleed-through from the reverse side of the page.

Faint, illegible text in the middle column, likely bleed-through from the reverse side of the page.

Faint, illegible text in the right column, likely bleed-through from the reverse side of the page.

Winter

The winter season is a time when you must be extra careful. A few precautions can help you and your car.

Precautions

Before the winter months, have your car inspected by a qualified mechanic. Necessary repairs should be done.

Brake system

Have your brake system inspected before the winter. It should be inspected by a qualified mechanic. You can use a brake fluid tester to check the fluid level.

Winter operation

The winter months often bring with them severe changes in the weather, and you must not only adopt a correspondingly careful attitude to driving but also take a few precautions to ensure that your BMW comes through the winter months reliably and without breakdowns.

Precautions for the vehicle

Before the cold season of the year commences, you are recommended to take your car to a BMW dealer, or any other qualified service establishment for the necessary winter preparations to be carried out.

Brake system

Have your car's brakes checked regularly before and after each winter driving period by a BMW service station. This work can usually be combined with whatever routine maintenance happens to fall due.

Engine oil

Comply with the appropriate **engine-oil requirements**, and do not wait until the next scheduled oil change to fill the engine with winter-grade oil if the weather suddenly turns cold.

Checking oil levels

Apart from checking oil levels, no special winter operating precautions are needed on the manual gearbox/automatic transmission, final drive, power steering, hydraulic brake system or self-levelling suspension.

Coolant

The coolant on your BMW already contains a long-term antifreeze and corrosion inhibitor. The concentration must be kept at 50% all year. This will provide antifreeze protection down to approx. -34°F (-37°C).

Use only factory-approved long-life nitrite- and amino-free antifreeze and corrosion-inhibiting additives. BMW dealers know the approved grades.

Renew the coolant **every 2 years**. Check antifreeze concentration before and during the cold season of the year. At the same time, inspect the cooling system for leaks and renew any coolant hoses which have become porous or brittle.

Engine temperature is regulated by the coolant thermostat according to outside temperature and engine load. For this reason, **no radiator cover should be fitted** or the radiator grille blocked off.

Battery

The engine will not start reliably unless the battery is fully charged. Remember that a cold battery is less efficient, yet the demands made on it are more severe than in warm weather.



Hints

Door locks

Use only factory-approved care products* on the door locks, to prevent unreliable operation.

Those products also help to prevent the locks from freezing; but if a lock should freeze despite these precautions, the key can be heated before inserting to thaw out the lock.

Rubber seals on doors, hood and trunk lid

To prevent rubber seals on doors and lids from freezing, treat them with a rubber care product or silicone spray.

Paint and parts

The car's paintwork or polished metal parts should be protected before and during the winter months by applying suitable bodywork care products*.

In cold weather we recommend carrying the following items in case of emergency:

- a quantity of **sand** for traction on ice covered slopes
- a **shovel** to extricate the car from snowdrifts
- a **plank** to act as a support for the car's jack
- a **brush and ice scraper** to clean the windows and body panels if they are covered with snow or ice.

Snow chains are permitted on the rear (driven) wheels only. If used fit them early enough. They increase driving safety on snow and ice, enable the car to climb hills without slipping and reduce braking distances. The driver must, however, accustom himself to the car's changed handling characteristics. Remove the snow chains as soon as possible, as on clear roads they wear out very rapidly.

Use only snow chains according to SAE J 1232 classification "S". The snow chains may be used on drive wheels (rear) only.

Caution:

Even if your local speed limit for cars with snow chains is higher, or there is no official speed limit, do not exceed 31 mph (50 km/h).

Winter

When p
allow p
weather
counter
the telep
clubs p
local ro
mounta

Before

Remove
outside
snow fr
and frui
and ob
from th
ventilati
so that

* Available from BMW dealers

Winter driving hints

When planning a fairly long trip in winter, allow plenty of time, in case severe weather conditions and bad roads are encountered. Local papers, radio and TV, the telephone service and the automobile clubs provide a source of information on local road conditions and whether certain mountain passes are open to traffic.

Before starting a trip

Remove ice and snow from the windows, outside mirrors and light lenses. After a snow fall remove it from the roof, engine and trunk lid to prevent it from blowing off and obscuring your vision. Clear snow from the air entry grilles for the heater/ventilating system below the windshield, so that airflow is not impeded.

Before getting into the car, try to remove slush, snow and ice from your shoes to avoid the risk of slipping off the pedals.

Driving when wearing ski boots is definitely not recommended, as it is then difficult to operate the pedals sensitively or to avoid touching the wrong pedal accidentally.

After starting a cold engine

Particularly at temperatures below +5° F (-15° C), the gear shift may be stiff and the car's suspension may not respond smoothly for the first few minutes of a trip, and other items of equipment may prove noisier in operation. This is unavoidable while the oil is still thick.

To improve traction

On icy or snow covered roads and in hilly country when the car is otherwise unladen, 110 lb (50 kg) of ballast can be carried in the trunk. Make sure that the ballast is secure and cannot slip.

Driving on slippery roads

When driving on slippery surfaces, depress the accelerator smoothly and slowly, and shift up to a higher gear quite early to avoid the use of high engine speeds. Keep a particularly large safety margin between your car and the one in front. Select the next lower gear when conditions permit before reaching an uphill or downhill gradient.

Warning:

On slippery surfaces, never downshift in order to obtain braking action. This could result in rear wheel slip and reduced vehicle control. Your vehicle's ABS will not prevent this kind of loss of control.

Driving
tips

Hints

Brakes

When braking on surfaces affording only poor grip, particularly on hills, always try to prevent the wheels from locking, since locked wheels cannot be steered. If the wheels lock, release the brake pedal momentarily and then depress it again. This braking principle not only enables you to bring the car to a halt on an icy surface, but may even prove sufficient to help you steer around an obstacle.

Caution:

Always declutch if braking with higher pedal pressures on slippery roads or on different road frictions.

On winter roads, tire grip is often very poor, and the driver must remember that braking distances are much greater than usual in many situations.

If the car skids

Ease up on the accelerator and disengage the clutch by pressing the clutch pedal down; on automatic transmission cars, push the selector lever to "N". Try to steer into the skid and get the car back under control in this way.

If the car is immobilized

If the car is immobilized in deep snow, sand or soft ground, pack some form of material under the rear wheels to provide extra grip before the car digs itself in too far. If no other material is available, use the car's floor mats. If possible, obtain help to push the car back on to a firm surface. With a degree of skill, the car can be rocked out of the holes caused by spinning rear wheels: use a light throttle opening and select a forward gear and the reverse gear in rapid succession, but avoid spinning the wheels, or the car will sink in deeper still. The parking brake can be applied lightly to prevent one rear wheel from spinning; remember to release it afterwards.

Caution:

If the vehicle becomes stuck in deep snow, make sure that the snow is kept clear of the exhaust pipe.

To assure sufficient fresh air ventilation, open a window slightly on the side of the car that is out of the wind.

Parking

When parking your BMW, prevent it from rolling away by selecting 1st gear or reverse as appropriate, or moving the automatic transmission selector to "P". Apply the parking brake if parked on a slope. To prevent the parking brake linings from freezing to the drums in cold weather, use the parking brake to bring the car to a standstill from a slow speed, so that the linings and drums are dried by the heat thus generated.

During a

During a
ing the
ice from
sure the
moveme

t it from
gear or
ing the
to "P"
od on a
ake in-
in cold
to bring
speed
dried by

During a break

During a break in the journey, or when filling the tank, remove built-up snow and ice from inside the wheel arches, to ensure that the steering and suspension movements are not impeded.

Roof rack

To ensure the lowest possible roof loads and optimum drag characteristics, use only BMW tested and approved luggage and ski racks. When installing a roof rack, make sure that the mountings fit securely to the roof and are located as far apart as possible.

The roof load must be evenly distributed and not too large. Always stow the heaviest items at the bottom.

Make sure that luggage on the roof is tight and properly secured so that there is no danger of it shifting or even coming loose. Consider the danger to other road users.

Drive smoothly, avoiding jerky starts and sudden braking, and do not take corners and curves too fast.

Luggage on the roof increases the frontal area of the car, leading to higher fuel consumption and roof stresses.

It is recommended that the luggage rack be taken off the car when not needed.

The ski rack should be loaded so that the tail ends of the skis point forward. Put only one pair of skis in each holder with poles in the trunk. Check all holders regularly.

Ski racks to match your car can be obtained from your BMW dealer.

Please comply with applicable state laws.



Hints

Antilock Brake System (ABS)

BMW's unceasing efforts to improve the active safety of its vehicles have led to the development of the antilock brake system (ABS).

Whenever a brake application is made, the ABS fulfills two fundamental requirements:

- Maintaining the car's stability on varying surfaces (asphalt, concrete, mud, wet roads, snow and ice)
- Ensuring that the car can be steered and maneuvered under these adverse conditions.

These requirements must be seen in the light of certain essential accompanying factors:

Even ABS is unable to prevent the natural laws of physics from acting on the car. It cannot, for instance, avoid the consequences of braking when there is insufficient distance remaining to the car in front, when cornering limit speeds are exceeded or if there is a risk of aquaplaning (tires riding up on a cushion of water lying on the road surface). It remains the driver's task to judge speeds and brake applications correctly in such conditions.

The fact that the car may be equipped with ABS must never, despite the increased safety margins this system frequently affords, tempt the driver into taking risks which could affect his safety and that of other road users.

Driving a car equipped with ABS

After the engine has been started, the yellow ANTILOCK warning light on the instrument panel will go out.

The system itself is then in working order, but does not come into action until road speed exceeds approx. 2.5 mph (8 km/h). After this minimum speed limit has been passed, the ABS can prevent the wheels from locking when the driver applies the brakes. If the speed drops below approx. 2 mph (3 km/h), the ABS will cease to operate so that in theory the wheels could lock at the very end of a brake application, though in practice this is not critical at such a slow speed. The ABS regulating cycle is repeated over and over again within fractions of a second. To inform the driver that his brake application has caused the ABS to come into action, a pulsating effect is noticed at the brake pedal, together with a characteristic "chattering" noise. As a warning to watch out for surfaces on which the tires cannot grip well, the chattering sound is heard when the ABS is controlling the braking pressure; this reminds the driver to reduce speed to suit the poor road conditions.

The ABS shortens any given line on (and on etc.). The longer base, s wheels tend to lateral a may be fitted, stability steering signals. Any unauthorised proper proved dated light on. The br tionally cards equipped ever, tion is but wh

g order
ntil road
8 km/h)
as been
wheels
bles the
approx.
e to op-
is could
applica-
t critical
gulating
er again
orm the
on has
ction, a
e brake
teristic
o watch
cannot
s heard
braking
r to re-
d condi-

The ABS is capable of achieving the shortest possible braking distances in any given conditions (either in a straight line or when the steering wheel is turned, and on smooth asphalt, ice, wet roads, etc.). The braking distance may be slightly longer on loose surfaces on top of a firm base, such as snow, since the skidding wheels of a conventionally braked car tend to build up a buffer of the loose material as they are forced through it. This may also be the case if snow chains are fitted. However, the benefits of greater stability, and the fact that the car can be steered, more than outweigh this occasional slight drawback.

Any modification or repair of the ABS by unauthorized personnel can lead to improper working order. Always fit the approved tire sizes. Any malfunction is indicated by the yellow ANTILOCK warning light on the instrument panel coming on. The brake system then operates conventionally and with precisely the same standards of performance as on cars not equipped with ABS. Keep in mind, however, that the most effective braking action is not achieved with locked wheels, but when the wheels are just turning.

Locked wheels can be dangerous, as locked front wheels can no longer be steered, and locked rear wheels cause the car to slide sideways or spin.

Caution:

Although the ABS is very effective, always remember that braking capability is limited by tire traction. Always adjust your driving speed according to the road and traffic conditions. Do not let the extra safety afforded by the ABS tempt you to taking extra risks. The ABS cannot overcome the laws of physics.

ABS cannot prevent accidents, including those resulting from excessive speed in turns, following another vehicle too closely, or aquaplaning. The capabilities of an ABS equipped car must never be exploited in a reckless or dangerous manner which could jeopardize your safety or the safety of others.

Disk brakes

A disc brake system offers optimum braking efficiency, smooth response, and a high load capacity. The high temperatures which occur during brake applications, e.g. on mountain passes when driving quickly, necessitate a maximum degree of cooling which is provided by the air flow generated by the peripheral speed of the brake discs and wheel design. Altering vehicle design could inhibit air flow and impair braking effectiveness.

Corrosion and light rust

Wet conditions, dirt, salt spread on the roads in winter and brake disc corrosion can impair braking performance by increasing braking distances, by altering the car's normal brake force distribution or by causing variations in the coefficient of friction at the various wheels, so that the car pulls to one side.



Hints

A slight rust film may develop on any disc brake-equipped vehicle parked for an extended period of time. The rust film will be substantially less or non-existent on the brake disc surface protected by the brake pads; therefore, after such periods of extended parking, the driver may notice a slight pulsation during braking. This pulsation will disappear as the brakes are used again. Slightly heavier than normal applications during braking will accelerate the rust removal process.

To assure proper seating of the brake pads to the discs to maximize braking effectiveness, it is essential to observe the break-in instructions for the braking system of a new vehicle or whenever new brake discs and/or pads are installed.

See operating instructions, break-in rules.

BMW brake components, wheels and tires have been carefully selected and engineered to provide a high degree of control under severe and diverse operating conditions. It is therefore recommended that BMW replacement parts be used and brake components, wheels and tires not be altered, to maintain the carefully balanced braking and handling characteristics designed into your vehicle.

Keeping disc brakes in shape

Every now and then disc brakes should be applied quite hard once or twice from high speed – provided traffic conditions allow. The high brake pressure produced ensures that the brake pads and discs are kept clean.

Similarly, on long trips in poor weather conditions, especially in winter when salt has been spread on the roads, it is advisable to apply the brakes firmly from time to time. This also tests their efficiency in the prevailing conditions (take care at temperatures around freezing point). Each test application allows the self-cleaning action to take place and thus ensures the brakes are operable even under the worst weather conditions.

In wet conditions or during rainfall, it is advisable to apply the brakes briefly with light pedal pressure every few miles. The heat generated in this way keeps the discs and pads dry for a certain period.

Before you park the car after driving through the rain, and especially if salt has been spread on the roads, lightly brake the car to a standstill so that the brake discs remain dry and cannot corrode easily.

If the brake discs already show signs of corrosion, it is possible to cure the problem in its early stages by applying the brakes hard several times. Take care not to endanger other road users!

The most effective braking action is always achieved not with locked wheels, but when the wheels are still just turning – the result obtained by the anti-lock brake system.

Locking
locked
steered
the car
if brake
the brake
pads is
paired.
The en
ing the
friction
brake
gear u
This te
"engine
The br
checke
winter,
preson

Locking the wheels can be dangerous, as locked front wheels can no longer be steered, and locked rear wheels cause the car to slide sideways or spin.

If brake disc corrosion is advanced and the brake pads are glazed, the discs and pads should be inspected, cleaned or repaired.

The engine's braking force due to operating the engine with closed throttle and frictional loss can be utilized effectively to brake the vehicle by selecting a lower gear up to the rpm limit of the engine. This technique is commonly referred to as "engine braking".

The brake system of your BMW should be checked regularly before and after the winter, possibly in conjunction with the prescribed inspection work.

We recommend you consult a BMW dealer or any other qualified service and repair establishment without delay in the event of any problems occurring in the brake system.

Caution:

The movement of the brake pedal must never be obstructed by a floor mat or any other object. In case one of the two brake circuits fails, increased pedal travel is required to bring your vehicle to a full stop.

Never coast with the clutch pedal depressed, the shift lever in neutral, or the ignition switched off.

Tires

Information for your safety

The factory-approved **radial-ply tires** have been chosen to suit your BMW and provide both optimum road safety and the desired level of ride comfort.

The condition of the tires and maintenance of the specified tire pressures are vital factors affecting tire life and also road safety to a very high degree.

Incorrect tire pressures are a frequent cause of complaints concerning tires. Furthermore, they may seriously affect the road-holding of your BMW.

Check tire pressure at regular intervals and before starting fairly long trips, but at least every two weeks.

When increasing the load, adjust to the specified value.

Warning:

Do not overinflate tires. Overinflated tires can result in sudden deflation because they are more likely to become punctured or damaged by road debris or potholes, curbs, etc.

Do not overload the tires and exceed the specified vehicle capacity weight. Overloading the tires can overheat them, possibly causing a deflation.

Hints

If tire pressures are lower than specified, this will adversely affect road safety/stability by reducing lateral locating force. The increased degree of tire sidewall flexing will lead to excessive heat build-up and thus introduce an element of risk into high speed driving. Fuel consumption will be increased by the tire's greater rolling resistance, and tread wear will be more rapid and lead to tire pre-damage. Keep in mind that a pre-damaged tire may fail much later at less load. If you notice a loss of pressure, have the tire checked for leaks immediately. Do not forget to check the spare tire as well: it should be kept at approx. 4 psi (0.3 bar) above the specified pressure for a fully loaded vehicle.

If tire pressures are too high, ride comfort will suffer, the tire may lack grip and tread wear will again be rapid and uneven.

Tires have to withstand very severe loads at high speeds, particularly in hot weather and at the maximum weight limit for your car. Remember to increase tire pressures if loads are high, and not to exceed the gross weight limit.

Warning:

For your own safety: check tire pressures regularly!

Incorrect tire pressures cause increased tire wear and adversely affect road-holding of the vehicle, leading to loss of control and personal injury.

Do not drive with a flat tire. Always keep in mind: Flat tires affect the ability to steer or brake the vehicle (e.g. on bridges or in tunnels).

Tire treads – tire damage

Check the condition of the tires frequently: look for damage, stones and nails, premature wear and overall tread pattern depth.

The tire tread is regarded as acceptable by law in many countries if only 0.04 in. (1 mm) deep, but it is advisable to renew tires when the tread depth has worn to 0.12 in. (3 mm).

Below this depth, there is a serious risk of aquaplaning at even moderately high speeds when the roads do not appear to be too wet. If the tires wear down to 0.063 in. (1.6 mm) tread depth, a wear indicator will become visible at the base of the tread pattern as a reminder that the legal limit of tire wear is approaching. Always match your road speed to the condition of your tires – particularly the remaining tread depth – and to weather conditions.

Tires: m
grooved
the tire

Warning
Do not
showing
because
tion car
person:

When c
wedge
the tire
is know
ing, an
loss of
ping a
wet ros

Tires must never have their treads regrooved, due to the risk of damaging the tire carcass.

Warning:

Do not drive with worn tires or tires showing cuts, bruises or other damage because they may lead to sudden deflation causing loss of vehicle control and personal injury.

When driving on wet or slushy roads, a wedge of water may build up between the tires and the road. This phenomenon is known as aquaplaning or hydroplaning, and may cause partial or complete loss of traction, vehicle control or stopping ability. Always reduce speed on wet roads.

Any foreign body (nail or similar sharp object) penetrating the tire may cause a slow leak, which will be recognized by the need to correct the tire pressure more frequently. In this event the tire should be checked and either repaired or replaced as soon as possible by your BMW dealer or a specialized tire workshop.

Drive at a moderate speed over poor road surfaces and approach unavoidable obstructions, such as a curb or severe bump in the road, with care so that the inner structure of the tire does not suffer internal damage invisible to you.

Take care not to damage the tire sidewalls when parking or driving onto loading ramps, car lifts, etc.

Avoid overloading your BMW – especially on vacation trips. Overloading the vehicle can also exceed the tire's permitted load capacity and thus cause premature or subsequent damage.

Tire damage (sudden loss of pressure) can be extremely dangerous for both yourself and other road users.

Replacing tires

Only tires of the same type and construction must be fitted on all four wheels. A mixture of cross (bias)-ply and radial-ply tires should not be used, as it will alter the vehicle's handling properties.

Furthermore, all tires should be of the same make and tread pattern, in order to maintain the good ride, the ABS function and the handling properties of your BMW.

BMW does not approve of the use of remolded or retreaded tires, owing to the possibility of differences in the tire carcasses and their sometimes very advanced signs of aging, which can have a detrimental effect on their durability and, under certain circumstances, the car's handling and safety.

Hints

Tire tread wear on the front wheels tends (for design reasons) to be slightly more rapid on the outer shoulders of the tire, whereas on the rear wheels it is concentrated more on the inner shoulders and the center of the tread. For this reason, the best and most consistent road-holding and grip are obtained if the tires are not interchanged between the front and rear wheels, although overall tire life may then be slightly reduced.

On the other hand, we recommend that front and rear wheel alignment be checked once a year and whenever new tires are installed. Any excessive rates of tire wear imply that wheel alignment is incorrect; this should be checked and repaired.

If, as a means of prolonging tire life, you wish to have the wheels rotated, please bear the following in mind:

Changing the wheels from front to rear on the same side can have, in certain conditions, only a negligible effect on the service life, whereas the handling and braking as well as the road-holding may be adversely affected.

If desired, the spare tire can also be put into use. In this case one must remember that this spare tire, possibly new, must be broken in and will not have at first the same degree of adhesion. Rotating the wheels must be done on the same side and at short intervals (approx. 3,000 miles [max. 5,000 km]).

Tires, which are 10 years and older, should only be used if they are fitted and to be driven to wear off.

Spare tires, 6 years and older, should only be used in an emergency and not used mixed with new tires. The date of manufacture is printed on the tire. DOT . . . 258 means: the tire was produced in the 25th week of 1988.

Tires and rims

We recommend the exclusive use of BMW approved tires.

For safety precaution, makes and sizes are specified. Please consult your BMW dealer. Obey legal rules.

The knowledge of tire and rim markings will help you make the right choice. The following designations are possible:

e.g. 225/55 R 16 95 H

Tire width in mm —
Cross sectional ratio in % —
Code letter for radial tires —
Rim diameter in inch (on TRX- and TD-tires in mm) —
Load rating code —
Speed rating code letter (on ZR-tires in front of the R) —

The spe
maximu
summe

S =
T =
H =
V =
ZR =

Permis:
tires:

C -
T -
H -

Design:
rim:

Hump:
Code le
Symbo
Rim dia
Hump:

* on TR-

The speed rating code letters indicate the maximum permissible road speeds for summer tires (subject to legal limits):

- S = up to 110 mph (180 km/h)
- T = up to 118 mph (190 km/h)
- H = up to 130 mph (210 km/h)
- V = up to 149 mph (240 km/h)
- ZR = over 149 mph (240 km/h)

Permissible maximum speeds for winter tires:

- Q = 100 mph (160 km/h)
- T = 118 mph (190 km/h)
- H = 130 mph (210 km/h)

Designation on pressed steel and alloy rim:

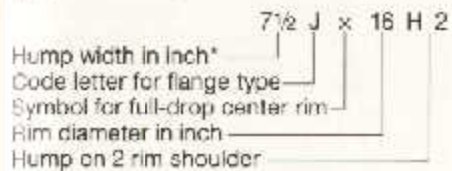

* on TR- and TD-tires in mm

The tire valves are provided with screw dust caps to keep out dirt. If dirt enters the valve, a slow leak may result.

Caution:

When replacing or changing tubeless tires, always replace the rubber valve as a safety precaution.

Improper treatment can endanger your personal safety. If you are not familiar with the pertinent safety rules, ask your BMW dealer to perform the necessary work.

Winter tires

If winter tires (radial-ply tires with special winter tread pattern) are installed, they must be of the same make and tread pattern on all four wheels in the interests of good directional stability and steering control.

Your BMW dealer will be glad to advise you on selecting the right winter tire for the anticipated operating conditions.

Always adhere strictly to the maximum road speeds specified for your winter tires.

When tread depth is worn to less than 0.16 in. (4 mm), tires become much less effective in winter, and should be replaced as a safety precaution.

Observe the specified **tire inflation pressures** and have the wheels balanced whenever you change a tire or wheel.

Hints

The following BMW rims and tire sizes are approved:

Radial-ply tubeless tires	Pressed-steel rims	Alloy rims
235/50 ZR 16	–	7½ J × 16 H2
225/55 R 16 95 H M + S	–	7½ J × 16 H2

Warning:

The use of rims and wheel bolts that do not meet the specifications of the original factory installed equipment will affect the safe operation of your vehicle and may cause an accident and personal injury.

Never mix tires of different design, such as steel-belted radials with radial bias-belted or bias-ply tires, etc. Mixing tire types will adversely affect road-holding and can lead to loss of vehicle control.

Use only snow chains according to SAE J 1232 classification "S". The snow chains may be used on drive wheels (rear) only.

We recommend the exclusive use of BMW approved snow chains.

Before undertaking any technical modifications to your car, please consult a BMW dealer (quoting the chassis number) concerning the practical value, legal position and factory attitude to such modifications.

Any unauthorized modifications to your car may void your warranty. (See your Warranty Booklet.)

BMW Service	116
Care and maintenance	117
Storage, vehicle laid up and out of use	123



Maintenance requirements

BMW Service

The BMW Maintenance System has been devised with the following objectives: maximize vehicle safety, reliability, and resale value by minimizing breakdowns resulting from wear, at minimum cost and inconvenience by computing maintenance intervals based upon the specific manner in which each individual vehicle is driven.

The advanced technologies at BMW have led to the development of the unique BMW Service Indicator System which computes the actual optimum maintenance requirements based not only upon the accumulated mileage, but taking into account important factors such as engine coolant temperatures, high or low engine speeds.

Actually, a vehicle driven for 50,000 miles (80,000 km) of short trips in the city with numerous cold starts and prolonged periods of idling requires more maintenance than a vehicle driven for the same mileage with long distances at low engine speeds, primarily at operating temperature.

Before the computed maintenance (Oil Service, Inspection I and II) begins, the Pre-delivery Inspection and the 1,200 mile (2,000 km) Break-in Inspection has to be performed.

An inspection of the vehicle body is required under the terms of the BMW Warranty-Rust Perforation.

Make sure that confirmation of maintenance work is always entered in the Service Booklet. You may need this for warranty claims or to justify its resale or trade-in value.

Care

Since many automotive suppliers improve reliability

The oc BMW, applied standar

The hig only to as far: to pro sists o sionpre only p dip pro als spe lengthy floor p PVC o based

is re-
V War-

ainte-
e Ser-
or war-
ale or

Care and maintenance

Since the car's paint is exposed to so many potential environmental hazards, automobile manufacturers and paint suppliers are constantly working on further improvements to the strength and durability of modern paints.

The composition of the paints used by BMW, and the manner in which they are applied, are to the very latest technical standards in this specialized field.

The high-gloss paint finish is chosen not only to appeal to owner's personal taste as far as the color is concerned, but also to provide maximum protection. It consists of several layers for reliable corrosionproofing; the body cavities are not only primer-coated by the cathophoretic dip process, but also coated with materials specially developed for this purpose in lengthy tests. The entire underside of the floor pan is given a sprayed-on, resilient PVC coating, followed by complete wax-based undersealing.

Have the body including the underside of the floor pan examined by a BMW dealer. Full details are given in the Warranty Booklet and the Service Booklet.

It is always more pleasant to drive a clean, well-kept car, but it is equally true to say that regular care and maintenance can make a big contribution to safety and to your car's resale value.

The points to watch are listed below.

A large number of external influences can affect the quality and appearance of your car's paint, some of them purely local in origin. They govern the amount of care the paint will need and how often it should be attended to.

Maintenance requirements

Road dust and dirt, the airborne deposits encountered in industrial areas such as fly ash, lime and soot, even tar stains, dead insects, bird droppings and the stains left when the car is parked under trees all contain various chemicals which, if allowed to remain on for a long time, can damage the paint in the form of patches, blisters, corrosion and flaking paintwork. The car should therefore be washed as often as necessary.

In **industrial areas**, the horizontal panels of the body in particular may suffer from deposits of fly ash, lime, oil soot or substances containing sulphur dioxide ("acid rain"), as well as other less easily identified deposits. Only regular care of the paint can avoid or minimize damage in such circumstances.



Maintenance requirements

In **coastal regions** the high salt content and humidity of the atmosphere greatly increase the risk of body panel corrosion.

In the case of **mechanical damage** caused by sand, road salt, grit etc., the paint surface may be damaged or penetrated, and corrosion may then spread across the panel under the paint.

To protect the car from the start against gradual deterioration of the paint in areas of high atmospheric pollution or where "natural" substances in the air could damage the paint finish (industrial zones, railways, sap and resin from trees, pollen, bird droppings), it is important to wash the car once a week. In severe cases, wash the car whenever the paint finish appears to be dirty.

Remove spilled fuel, oil, grease or brake fluid at once, as these substances can attack the paint or change its color.

Bird droppings should also be removed without delay, or they will damage the paint.

A new BMW can be put through an automatic car wash, or washed by hand, as soon as it begins to be used on the road.

When using an automatic car wash, make sure the accessories (e.g. spoiler) will not be damaged. If necessary, contact the car wash owner.

Dead insects should be soaked and wiped off before the main car wash.

Washing the car should be delayed if the engine compartment lid is still hot, or if the car has been parked or is still standing in strong sunlight. Otherwise, spots may form on the paint surface.

When using an **automatic car wash**, try to choose one with low brush pressure and an ample supply of rinsing water. Most modern car washes satisfy these requirements. However, the areas not fully reached by the automatic system – door sills, panel flanges and seams on doors and lids etc. – should be cleaned by hand.

During the cold season of the year in particular, it is advisable for the car to be washed more frequently, since the heavy dirt deposits and salt from wet roads are more difficult to remove and will damage the entire car if left on too long.

When the car is washed, take the opportunity to clean the interior and trunk with a vacuum cleaner.

If you wash the car by hand, first soften the dirt deposits on the paint with a fine water spray, and rinse them off. Do not spray water directly into the air inlets or outlets of the heating/ventilation system.

After sponging of the sponge water. Wash the wheels and sills. After washing, thoroughly clean the spots. To protect the car, use the label. A

Maintenance requirements

After spraying down, wash the upper part of the body starting at the roof with a sponge, using plenty of cold or lukewarm water. Rinse out the sponge frequently.

Wash the lower part of the body and the wheels last, if possible keeping a separate sponge just for these areas.

After washing, rinse the car again thoroughly with a hose and dry it with a clean chamois leather to prevent discolored spots where the water was not removed.

To protect the paint, a paint-care product can be added to the water used for washing the car.

If washing with water alone is insufficient, a car shampoo or similar cleanser can be used in the concentration stated on the label. After this, rinse with plenty of water.

Caution:

After washing, the brakes may be wet and therefore less effective. Apply them briefly to dry the discs.

Any localized dirt patches or other contamination of the paint surface can best be seen after the car has been washed. Remove them as soon as possible. Eliminate tar stains with a special tar remover.

Polish the paint at these points to restore its appearance and protect it.

Please use only paint-care products containing carnauba or synthetic waxes, and heed the instructions on the labels.

It is quite easy to decide when the car's paint needs polishing or preservative treatment: water no longer forms large round droplets and tends not to roll off from the surface. Depending on use of the car, this may arise after some 3 to 4 months.

If the paint tends to lose its high gloss as a result of insufficient care, a suitable polish must be applied. Paint cleaner is needed if the finish is already dull or weathered. An abrasive polishing compound or paint restorer should only be used in very severe or obstinate cases. Remember that all polishes, cleaners or paint restorers act by removing a layer of paint and exposing paint which is still in good condition.



Maintenance requirements

Only if the new paint surface is most carefully protected will the overall brilliance of your car's paint be regained.

After care of the car's paint, remove traces of the products used from the windows with a suitable glass cleaner.

Minor paint damage can be touched up with either spray paint or a paint stick, which is used like a brush. The correct paint color designation is on an adhesive label in the engine compartment.

Damage caused by flying stones, scratches etc. must be touched up without delay, to prevent rust from forming.

If damaged areas of paint have already started to rust, use a wire brush to clean them up, and apply rust converter (protect your eyes and skin). Allow a few minutes for this to take effect, then rinse off with water and dry thoroughly. Apply primer and allow to dry, then apply the top coat. After a few days, polish the repaired area and apply a paint preservative.

More extensive paint damage should be professionally repaired in accordance with the manufacturer's instructions. The BMW Service Organization knows and will apply the full repair procedure to ensure a long-lasting repair of good appearance.

Another important note:

If a tarpaulin or similar sheet is used to protect the car against the weather, moisture condensate may collect (particularly in the case of plastic sheet) and cause the plasticizers to diffuse out of the paint. There is also a severe risk of scratching the paint surface: it is far better to protect your BMW against ultraviolet rays from bright sunlight and against rainfall etc. by giving it the full body care treatment described before. Ideally, in countries where the sun is extremely hot and powerful a canvas sunsheet should be stretched above the car.

Annual cleaning and protection or treatment of the engine, engine compartment, underbody, axles and other mechanical assemblies can be carried out by your BMW dealer. This not only reduces the risk of serious corrosion to a minimum, but also avoids short circuits caused by accumulated oil and dirt, and reveals leaks before they become severe. This treatment is particularly important at the end of the winter season.

For information on the Limited Warranty-Rust Perforation refer to your Warranty Booklet.

Polished metal parts should be cleaned regularly with water, to which a car shampoo can be added if required. Do not neglect this treatment in winter if salt is spread on the roads.

Alloy ri
cial whe
the wi
gressive
acids, i
rms sh
jet with
(60° C).
facture

To clea
recomr
vinegar
(and m
smear
Never c
pastes

Plastic
stery, r
sprayer
with wi
be add
becom
plastic
Never c
pers, fu

Maintenance requirements

Alloy rims should be treated with a special wheel-rim cleanser, particularly during the winter months. Do not use aggressive-action products containing acids, strong alkalis or abrasives. Alloy rims should not be cleaned with a steam jet with temperature higher than 140° F (60° C). Please heed the cleanser manufacturer's instructions.

To clean the **inside of the windows** we recommend a 1:1 mixture of water and vinegar. The inside surfaces of windows (and mirror glasses) can be cleaned and smearing avoided with glass cleaner. Never clean mirror glasses with polishing pastes or abrasive (quartz) cleansers.

Plastic components, leatherette upholstery, roof linings, light lenses and items sprayed matte black should be cleaned with water, to which a car shampoo may be added. Do not allow the roof lining to become soaked. If necessary, apply a plastic cleaner to plastic components. Never use solvents such as lacquer thinners, fuel etc.

Rubber components should only be cleaned with water or treated with a rubber cleanser or silicone spray.

Clean the **wiper blades** with soapy water. The wiper blades should be replaced twice a year, before and after the cold season.

Seatbelts should only be cleaned with a weak soap-and-water solution without removing them from the car. Never attempt chemical or dry cleaning, otherwise the fabric of the belts may be damaged.

Never allow automatic (inertia-lock) seatbelts to retract while they are still wet. Clean the seatbelts if they become dirty, as dirt penetrating the reel mechanisms could prevent them from locking or keeping the belts taut, thereby constituting a safety risk.

Carpet and **floor mats** can be cleaned. For details ask your BMW dealer. For easy cleaning unfold the holder to remove floor mats.

Care of upholstery fabric

The cloth used by BMW is notable for hard wear, good heat transmission, freedom from sliding, a soft and attractive surface and easy care.

If certain areas of the seat acquire an unwanted gloss as a result of heat, friction or moisture, they should be brushed "against the pile" with a slightly moistened brush.

The pile of velour material tends to lie flat in use; as with many furnishing fabrics and clothing materials, this is unavoidable and does not detract from its quality.

Fluff and loose threads or abraded leather particles on upholstery fabrics are best removed with a suitable lint brush. Clean off stains or large dirty marks at once with lukewarm water, car-interior cleaner or stain remover. Afterwards, brush the fabric to restore the pile.



Maintenance requirements

Seat upholstery fabrics can acquire a **static electrical charge**, particularly when atmospheric humidity is low. Persons touching metal parts of the body **after** leaving the car may then receive an unpleasant but harmless electric shock. Remember to touch an exposed metal part of the car while getting out; this will disperse the electric charge without its being noticed.

The **upholstery leather** used by BMW on its cars is a high grade natural product treated by the latest processes. If carefully looked after, it will retain its high quality for many years.

Regular (monthly) cleaning and general care is essential, since dust and road dirt penetrate the pores and creases and cause the surface to wear away and become brittle.

Clean the leather surfaces with a slightly moist cotton or woollen cloth, but do not allow the leather to become soaked at the seams. Dry the leather and rub it with a clean, soft cloth.

Very dirty areas on leather upholstery can be cleaned with a mild detergent (suitable for woollens) containing no brightening agents. Use 2 tablespoons to 1 US quart (one liter) of water.

When using leather care or cleaning agents, rub with a soft cloth and polish after the treatment.

Unightly bald patches or minor surface damage can be rectified with leather spray lacquer.

If the car is parked for a long time in bright sunlight, it is advisable to cover the seats and the head rests or, even better, the windows, to prevent bleaching of the colors.

Stains on the interior trim upholstery – except for real or imitation leather – should be removed with commercial foam spray. Brush down fabric surfaces afterwards. Rub plastic trim with a stiff sponge.

Wear patches on corduroy or velour fabrics are caused by pressure during frequent use and should be brushed "against the pile" with a slightly moist brush.

Warning:
Cleaning agents may be poisonous, hazardous or flammable. Keep them out of the reach of children.
Observe all warning and caution labels. Open doors or windows when cleaning the inside. Never use fluids or solvents that are not made for cleaning a car. Always read directions on the container before using any product.

Storage

If the c
for mo
mend
work b
any qu
vent de
riod.

1. Wash
the c
wax:
Clear
and r
nece
chec
BMW
2. Char
oil fil
norm
addit
corr
englr
3. Chec
and f

Storage, vehicle laid up and out of use

If the car is to be laid up and out of use for **more than three months**, we recommend that the following maintenance work be performed by a BMW dealer or at any qualified workshop in order to prevent deterioration during the storage period.

1. Wash the body and the underside of the car, clean the interior and, finally, wax the paint and chrome-plated parts. Clean rubber seals on lids and doors and rub them with talcum or glycerin. If necessary, have the undercoating checked or repaired in accordance with BMW factory recommendations.
2. Change the engine oil and replace the oil filter element while the engine is at normal operating temperature. As an additional anti-corrosion measure, a corrosion inhibitor can be added to the engine oil as specified by the supplier.
3. Check coolant level and concentration, and top up if necessary.

4. Check acid level in battery cells and top up with distilled water if necessary.
5. Drain the windshield washer fluid tank and lines.
6. The fuel tank should be filled, to prevent corrosion caused by moisture condensate.
7. Increase tire pressures to 60 psi (4 bar).

Immediately before the car is taken out of use, perform the following:

1. Foot brake and the parking brake should be applied while driving. This will keep the pads and linings dry and the brake discs and drums will not corrode.
2. Store the car in a dry, well-ventilated space. Engage reverse gear (Automatic transmission: selector lever position P). Do not apply the parking brake. If necessary, chock a wheel to prevent rolling.
3. Disconnect the negative lead from the battery. If there is any risk of freezing, remove the battery and store in a warmer place.

While the vehicle is laid up and out of use, perform the following:

1. The battery must be recharged at least every 3 months or it will become unsuitable for further use.
2. The air conditioning must be run briefly at least once a month at an ambient temperature of at least 41°F (5°C) (this is particularly important in the cold season of the year). Otherwise the compressor shaft seals may dry out and permit refrigerant to leak. The engine should run for this purpose until it reaches its normal operating temperature (coolant thermometer needle approximately midway between the two colored zones). This will avoid condensate formation and the risk of internal engine corrosion. If the car is not equipped with air conditioning, do not run the engine during the storage period.

Warning:

If the engine needs to be run for the above reasons, do so only in a well-ventilated space to avoid inhaling exhaust fumes.



Maintenance requirements

Restoring car to use

First recharge the battery, or replace it if necessary. The following maintenance work should then be carried out.

1. Change the engine oil and the oil filter element while the engine is at normal operating temperature.
2. Refill the windshield washer fluid tank with windshield washer solvent if necessary.
3. Restore tire pressures to the correct values.

The Inspection I, should be performed by a BMW dealer.

Technical data

Dimensions and weights	126
Engine data	126
Performance data	126
Dimensions and weights	127
Filling capacities	128
Transmission ratios	129
Electrical system	129
V-belts	129



Technical data

Engine data

Displacement – effective	304.4 cu.in.	(4988 cm ³)
Max. output at engine speed	296 hp 5200 rpm	(220 kW)
Max. torque at engine speed	332 lb-ft 4100	(450 Nm)
Cylinders	12	
Compression ratio	8.6	
Stroke/bore	2.95/3.31 in.	(75/84 mm)

Performance data

Top speed – manual transmission	155 mph	(250 km/h)
Top speed – automatic transmission		

Acceleration

0–50 mph (0–80 km/h)	4.7/5.3* seconds
Standing start 1/4 mile in	14.7/15.2* seconds

*Automatic model

Dimen

Length

Width

Height

Wheel

Front c

Rear c

Front t

Rear t

Min. tu

Min. tu

Unloa

(rea

acc

Permi

Permi

Permi

Maxim

Permi

Trunk

Technical data

Dimensions and weights

Length	188.2 in.	(4780 mm)
Width	73.0 in.	(1855 mm)
Height (unloaded)	52.8 in.	(1340 mm)
Wheelbase	105.7 in.	(2684 mm)
Front overhang	41.2 in.	(1045 mm)
Rear overhang	41.3 in.	(1051 mm)
Front track	61.2 in.	(1554 mm)
Rear track	61.5 in.	(1562 mm)
Min. turning circle (wheels)	34.6 ft	(10.6 m)
Min. turning circle (overall)	37.7 ft	(11.5 m)
Unloaded weight (ready for road, tank full according to FMVSS 110)	4123 lbs	(1870 kg)
Permissible gross weight	4905 lbs	(2225 kg)
Permissible front axle load	2425 lbs	(1100 kg)
Permissible rear axle load	2535 lbs	(1150 kg)
Maximum vehicle load	783 lbs	(355 kg)
Permissible roof load	165 lbs	(75 kg)
Trunk capacity acc. to VDA test	9.5 cu ft	(270 l)



Technical data

Filling capacities

		Notes
Fuel tank	24 US gal (91 liters)	Unleaded gasoline (87 AKI or 91 RON)
Windshield wipe-wash system	approx. 2.6 US quarts (2.5 liters)	For details, see page 83.
Headlight and fog light cleaning system	approx. 9.5 US quarts (9.0 liters)	
Intensive cleaning system	approx. 1.1 US quarts (1.0 liter)	
Cooling system including heater circuit	13.7 US quarts (13 liters)	For details, see page 81.
Engine oil	6.8 US quarts (6.5 liters) if oil filter is changed: + 1.1 US quarts (1.0 liter)	Brand name 4-stroke HD engine oil, rated SF/SG; for oil grades, see page 79.
Manual transmission	2.4 US quarts (2.3 liters)	Brand name non-hypoid gearbox oil SAE 80, specification MIL-L-2105 or API-GL 4 alternatively single-grade HD engine oil (mineral oil based) SAE 20/30/40, specification API-SF/SG (Contact your BMW dealer for details)
Automatic transmission	For oil change: 3.7 US quarts (3.5 liters)	Use only brand name automatic transmission fluids of Dexron [®] II. To avoid overfilling the oil level should only be checked at maintenance intervals. Contact your BMW dealer for further information.
Rear axle	2.0 US quarts (1.9 liters)	Brand name hypoid gear oil

Trans

1st

2nd

3rd

4th

5th

6th

Rever

Transmission ratios

	Manual transmission	Automatic transmission
1st	4.25	2.48
2nd	2.53	1.48
3rd	1.68	1.00
4th	1.24	0.73
5th	1.00	-
6th	0.83	-
Reverse	3.89	2.09

Electrical system

Battery 2 12 V, 65 Ah
or 1 12 V, 92 Ah

Alternator 140 A, 1960 W

Starter Bosch GF 12 V
1.1 kW

Spark plugs Bosch F 8 LCR

Electrode gap
0.7 + 0.1 mm (0.027 + 0.004 in.)

Firing order
1-7-5-11-3-9-6-12-2-8-4-10

V-belts

Alternator and power steering pump
6 K × 1080

Water pump and air conditioning compressor
5 K × 1165



ations.

Index

Acceleration figures 126
Accessory power socket 67
Airbag 34
Air conditioner 62
Air outlets 62, 64
Alarm system, theft deterrent 27
Alternator 129
Antifreeze 81
Antilock Brake System (ABS) 105
– warning light 13
Ashtray 66
Automatic Climate Control 62
Automatic Cruise Control 60
Automatic Stability Control (ASC) 61
– Automatic Stability + Traction Control (ASC + T) 61
Automatic transmission 57
– fluid 128
– kick-down 58
– selector lever 57
Axle loads 127

Back-up lights 97
Battery
– charge indicator 12
– electrolyte level 84
– specification 129
Blower control-ventilation/heating 62
– automatic climate control 62
Body dimensions
– overhang 127
BRAKE ASSIST INACT. 53
Brake fluid level check 80
– warning light 12
Brake (stop) lights 97

BRAKE LININGS 54
– pads 17
Brake system 60
Break-in information 16
Bulb changing 95

Capacities 128
Care and maintenance 117
Catalytic converter 71
Central locking system 24
Chassis number 76
CHECK BACKREST LOCK 54
CHECK CONTROL OK, function 53
CHECK LEFT BACKREST 53
CHECK RIGHT BACKREST 53
Child restraints 35
Cigarette lighter 67
Circuit breaker 39
Clock, digital 44
Cold starting 15, 16
Cold weather operation 101
Compression ratio 126
COOLANT TEMPERATURE 14, 81
Cooling system capacity 126
Cruise Control 60

Defrosting of windows 62, 63
Differential – see Rear axle 128
Dimensions 127
Dimmer switch 36
Disc brakes 107
Door locks 23
Door mirrors 31
Double locking system 23
Driver's seat adjustment 28
Driving hints 70

Electric seat adjustment 28
Electric seat heating 29
Electric window lifts 39
Electrical system 129
Electronic Damping Control (EDC) 41
Electronic Hydraulic Transmission 57, 58
Emission control system 71
Energy conscious driving 18
Engine break-in hints 16
Engine compartment 77
Engine data
– firing order 129
– hood 75
– oil adding 78
– oil grades 79
– oil level check 78
– **OIL PRESS LOW** 53
– specifications 126
Evaporative Emission Control System 71

Fasten seat belt warning reminder 33
Filling capacities 128
Firing order 129
Flashlight, rechargeable 66
Fog light switch 36
Fog light washer 38
Foreign countries, travel 72
Fresh air outlets 62, 64
Front seat adjustment 28
Front side marker 97
Front turn signal light 97
Fuel economy 18
Fuel filler flap 19
Fuel gauge 14
Fuel requirement 19

- Fuel reserve 14
- Fuel tank capacity 128
- Fuel and lubricants 128
- Fuses 86

- Glove boxes 66

- Hazard warning flashers 37
- Headlight
 - switch 36
 - flasher 36
- Headlight/fog light washer 38
- Headrests 28
- Heating and ventilation 62
- High-mount brake light 98
- High beam headlights 96
- Hood release 76
- Horn 13

- Ignition/starter switch 15
- Indicator lights 12
- Instrument light 36
- Instrument panel 11
- Intensive cleaning reservoir 83
- Interior light 98
 - switch 37
- Interior mirror 32
- Intermittent wiper action 38

- Jack 90
- Jump starting 88

- Keys 22

- Leather upholstery 122
- License plate lights 99
- Light switch 36
- Low beam headlights 95

- Make-up mirror 32
- Manual transmission 56
- Map-reading lights 37
- Memory for seat and mirror adjustment 32
- Microfilter 85
- Mirrors 31
- Mobile communication systems 74
- Modifications, technical 114
- Multi-Information Display (MID) 42

- Octane number 18
- Odometer 13
- Oil additives 78
- Oil level check, engine 78
- Oil pressure warning light 12
- On-Board Computer 46
- Output max. 126
- Oxygen sensor 71

- Paint care 119
- PARKING BRAKE** 53
- Parking lights 97
 - switch 36
- Pick-up points (wheel jack) 91
- Polishing/waxing 119
- Power socket 67
- Power steering 80, 129
- Power windows 39

- Radial-ply tires 109
- Radio 73
- Rear axle
 - oil capacity 128
 - oil grades 128
- Rear lights 97
- Rear side marker 97
- Rear view mirror 31
- Rear window defogger 65
- Remote control (door) 25
- Remote control (On-board-computer) 52
- Reporting safety defects 1
- Reverse gear, selecting 56
- Roof load 127
- Roof rack 105

- Seat adjustment 28
- Seatbelts 33
- Seat heating 29
- Service Indicator 43
- Side marker lights 97
 - switch 36
- Ski rack 105
- Snow chains 114
- Spare tire 90
- Spark plugs 129
- Starter 129
- Starting the engine 15
- Steering column adjusting 30
- Steering fluid level 80
- Stop lights 97
- Storage 123
- Stroke/bore 126
- Sunroof 40
- Sun visor 32

Index

Supplementary Restraint System (SRS) 34

Tachometer 14

Telephone 74

Theft deterrent system 27

Tires, punctures 90

Tire inflation pressures 20

Tool kit 86

Top speed 126

Towing 87

TRANS FAIL-SAFE PROG 54

Transmission (Manual)

– pattern 57

– oil capacity 128

– oil grades 128

– ratios 129

Traveling in foreign countries 72

Tread wear indicator 116

Trip odometer 13

Trunk capacity 127

Trunk light 25

Turn signal lever 36

V-belts, dimensions 129

Vehicle care 117

Vehicle dimension 127

Vehicle Identification Number 76

Vehicle load 127

Ventilation 82

Warning chime 47

Warning lights 12

Washer fluid tank 83

Washing/waxing 119

Wheel changing 90

Wheel chock 90

Wheel sizes 114

Wheel bolt torque 92

Wheel bolt wrench 90

Wheels, interchanging 112

Window lift circuit breaker 39

Window lift switches 39

Windshield and intensive cleaning system reservoirs 83

Windshield washer fluid tank 83

– capacity 128

Windshield washer jets 38

Windshield wipe/Washer lever 38

Winter operation 101

Winter tires 113

Wiper blades 94

Note:

Titles in bold print are indications of the Check Control, which refers to "Owner's Manual".

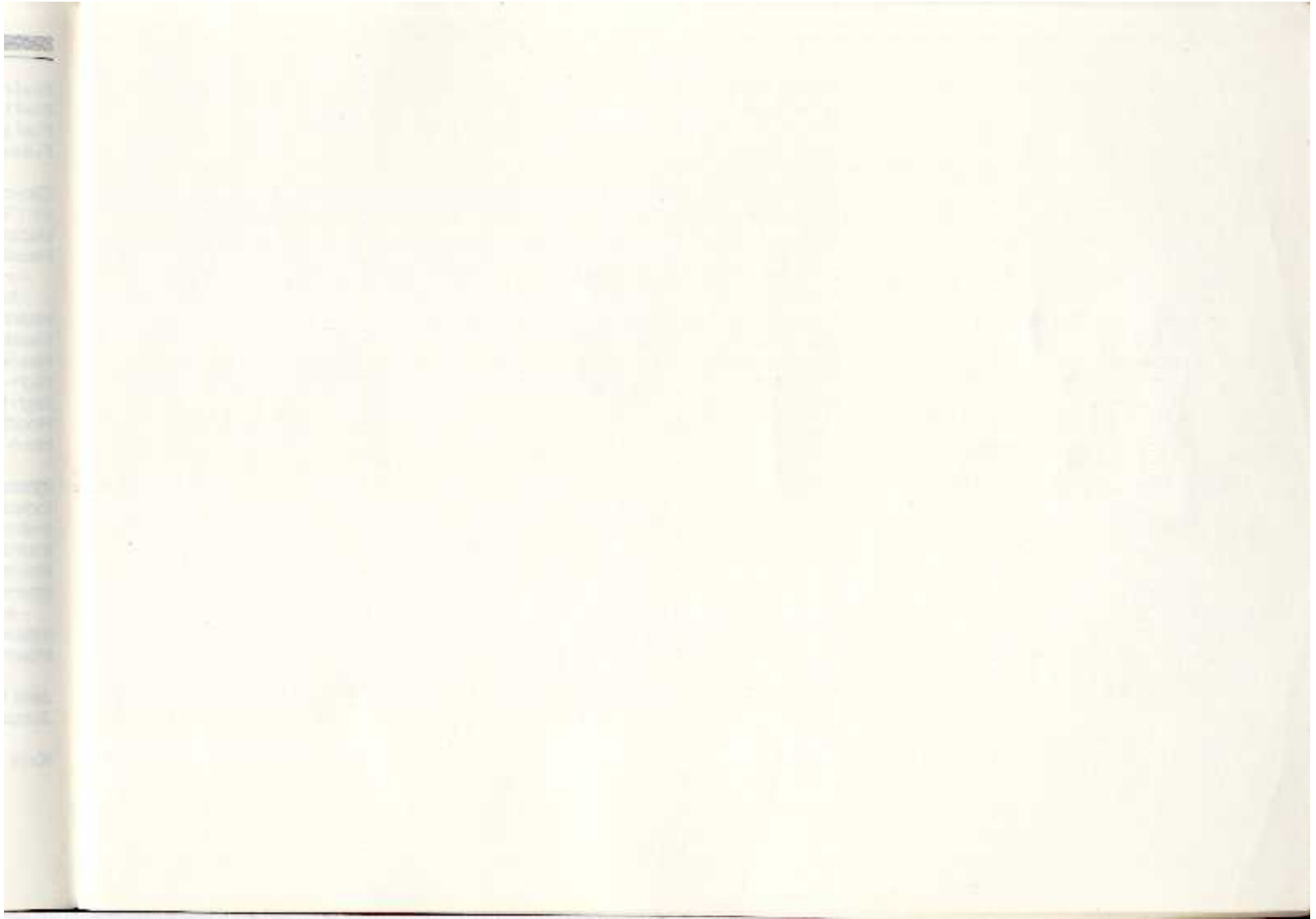





**The ultimate
driving
machine**

Order No. 01 47 9 782 609 US-englisch